



Operator's manual  
**HUSQVARNA AUTOMOWER®**  
**550 EPOS**



EN, English

Read the operator's manual carefully and make sure that you understand the instructions before you use the product.

---

# Contents

---

<b>1 Safety</b>	
1.1 Safety definitions.....	3
1.2 General safety instructions.....	3
1.3 Safety instructions for installation.....	4
1.4 Safety instructions for operation.....	4
1.5 Safety instructions for maintenance.....	4
1.6 Battery safety.....	4
1.7 To lift and move the product.....	5
<b>2 Introduction</b>	
2.1 Support.....	6
2.2 System description.....	6
2.3 Product description.....	6
2.4 System overview.....	7
2.5 Product overview.....	8
2.6 Symbols on the product.....	8
2.7 Symbols on the battery.....	9
2.8 Symbols in the app.....	9
2.9 General manual instructions.....	10
<b>3 Installation</b>	
3.1 Introduction - Installation.....	11
3.2 Primary components for installation.....	11
3.3 To prepare for installation.....	11
3.4 To examine where to put the reference station...	11
3.5 To examine where to put the charging station...	11
3.6 To examine where to put the power supply.....	12
3.7 To examine where to install the objects on the map.....	13
3.8 Installation of the product.....	15
<b>4 Settings</b>	
4.1 Schedule.....	21
4.2 Cutting height.....	22
4.3 Pattern.....	22
4.4 Operation.....	22
4.5 Accessories.....	23
4.6 General (Bluetooth® only).....	23
4.7 Security (Bluetooth® only).....	23
4.8 Automower® Connect (Bluetooth® only).....	24
4.9 Messages.....	24
4.10 Download firmware over the air (Firmware over the air FOTA).....	24
<b>5 Operation</b>	
5.1 Main switch.....	25
5.2 To start the product.....	25
5.3 To select operation mode Start.....	25
5.4 Operating mode - Park.....	25
5.5 To stop the product.....	26
5.6 To set the product to OFF.....	26
5.7 To charge the battery.....	26
<b>6 Maintenance</b>	
6.1 Introduction - maintenance.....	27
6.2 Maintenance schedule.....	27
6.3 Clean the product.....	28
6.4 Replacement of the blades.....	29
6.5 Replace the wheel brushes.....	29
6.6 Battery.....	29
6.7 Winter service.....	29
<b>7 Troubleshooting</b>	
7.1 Introduction - troubleshooting.....	31
7.2 Fault messages.....	31
7.3 Information and warning messages.....	37
7.4 LED indicator lamp on the charging station.....	38
7.5 LED indicator on the product.....	38
7.6 Symptoms.....	39
<b>8 Transportation, storage and disposal</b>	
8.1 Transportation.....	41
8.2 Storage.....	41
8.3 Disposal.....	41
<b>9 Technical data</b>	
9.1 Technical data.....	42
9.2 Registered trademarks.....	44
<b>10 Declaration of Conformity</b>	
10.1 Original EU Declaration of Conformity.....	45
10.2 Translated EU Declaration of Conformity.....	46
10.3 Original UK Declaration of Conformity.....	47

---

# 1 Safety

---

## 1.1 Safety definitions

Warnings, cautions and notes are used to point out specially important parts of the manual.



**WARNING:** Used if there is a risk of injury or death for the operator or bystanders if the instructions in the manual are not obeyed.



**CAUTION:** Used if there is a risk of damage to the product, other materials or the adjacent area if the instructions in the manual are not obeyed.

**Note:** Used to give more information that is necessary in a given situation.

## 1.2 General safety instructions



**WARNING:** Read the warning instructions that follow before you use the product.

- Read the Operator's manual carefully and make sure you understand the instructions before you use the product. Keep for future reference.
- This appliance is not intended for use by children or persons with reduced physical, sensory or mental capabilities (that could affect a safe handling of the product), or lack of experience and knowledge, unless they have been given supervision or instruction concerning use of the appliance by a person responsible for their safety.
- The product must only be used with the equipment recommended Husqvarna. All other types of use are incorrect.
- Do not use the product when persons, especially children, or animals are in the work area.
- To prevent damage to the product and accidents to vehicles and persons, do not install work areas and transport paths across public pathways.
- Do not use the product in areas where persons are not aware of the product.
- Warning signs must be put around the work area of the product if it operates in public areas. The signs must have the text that follows: Warning! Automatic lawn mower! Keep away from the machine! Supervise children!
- Do not run when you operate the product manually with appDrive. Always walk, be sure on footing on slopes and make sure to have balance at all times. Always wear substantial footwear and long trousers when you operate the product with appDrive.
- Do not touch moving hazardous parts, such as the blade disc, before it has come to a complete stop.
- Set the product to OFF before you clear a blockage, do maintenance or examine the product, and if the product starts to vibrate abnormally. Examine the product for damage before you start the product again. Do not use the product to it is defective.
- If an injury or accident occur get medical aid.
- Do not install the mains cable in an area where the product cuts. Follow the instructions to install the mains cable, refer to *Installation on page 11*. Installation must be done by service personnel.
- Do not connect a damaged cable or plug, or touch a damaged cable, before it is disconnected from the power outlet. Disconnect the plug from the power outlet if the cable becomes damaged while in operation. A worn or damaged cable increases the risk of electrical shock. A damaged cable must be replaced by service personnel.
- When you connect the mains cable to the power outlet, use a residual-current device (RCD) with a tripping current of maximum 30 mA.
- Only charge the product in the included charging station. For safe disposal of the battery, refer to *Disposal on page 41*. Incorrect use may result in electric shock, overheating or leaking of corrosive liquid from the battery. In the event of leakage of electrolyte, flush with water/neutralizing agent. Get medical aid if corrosive liquid comes in your eyes.
- Use only original batteries recommended by Husqvarna. Product safety cannot be guaranteed with other than original batteries. Do not use non-rechargeable batteries.
- Follow the installation instructions that includes to specify the work area, refer to *Installation on page 11*.
- Follow the instructions about to start and operate the product, refer to *Operation on page 25*.
- If there is a risk of thunderstorm, Husqvarna recommends that the mains cable to the charging station and the power supply unit to the reference station are disconnected to decrease the risk of damage to electrical components. Connect the mains cable and the power supply again if there is no longer a risk of thunderstorm.
- Follow the maintenance instructions and if necessary use Husqvarna original spare parts, refer to *Maintenance on page 27*.
- For technical data such as weight, dimensions and noise emission values, refer to *Technical data on page 42*.

- The operator is responsible for accidents or dangers that occurs to other persons or property.
- The product must only be operated, maintained and repaired by persons that are fully conversant with its special characteristics and safety regulations.
- It is not permitted to change the initial design of the product.
- Obey national regulations about electrical safety.
- Husqvarna does not guarantee full compatibility between the product and other types of wireless systems such as remote controls, radio transmitters or equivalent.
- The built-in alarm is very loud. Be careful, especially if the product is handled indoors.
- Operation and storage temperature is 0-50 °C / 32-122 °F. Temperature range for charging is 0-45 °C / 32-113 °F. Too high temperatures might cause damage to the product.

### 1.3 Safety instructions for installation



**WARNING:** Read the warning instructions that follow before you use the product.

- Do not install the charging station in an area where there is a risk that persons trip on it.
- Do not install the charging station, including any accessory, at a location that is below, or within 60 cm / 24 in. from, any combustible material. In case of malfunction, heating of the charging station and the power supply may occur and create a potential risk of fire.
- Applicable to USA/Canada. If power supply is installed outdoors: Risk of Electric Shock. Install only to a covered Class A GFCI receptacle (RCD) that has an enclosure that is weatherproof with the attachment plug cap inserted or removed.
- Do not install the charging station where there is a risk of standing water.

### 1.4 Safety instructions for operation



**WARNING:** Read the warning instructions that follow before you use the product.

- Keep your hands and feet away from the rotating blades. Do not put your hands or feet near or below the product when it is set to ON.
- Use the park mode or set the product to OFF when persons, especially children or animals are in the work area. Refer to *To set the product to OFF on page 26*. Husqvarna recommends to set the product to operate when the work area has no

activity. The product can cause injury to animals at night in work area, for example hedgehogs. Refer to *Schedule on page 21*.

- Make sure that there are no objects such as stones, branches, tools or toys on the lawn. The blades can be damaged if it hits an object.
- Do not lift the product or move it when it is set to ON.
- Do not let the product collide with persons or animals. If a person or animal comes in the way of the product, stop the product immediately. Refer to *To stop the product on page 26*.
- Do not put objects on top of the product, the charging station or the reference station.
- Do not use the product if the **STOP** button does not work.
- Always set the product to OFF when it is in operation. The product can only start when you enter the correct PIN code.
- Do not use the product at the same time as a pop-up sprinkler. Use the *Schedule* function so the product and pop-up sprinkler do not operate at the same time. Refer to *Schedule on page 21*.
- Do not put a transport path where pop-up sprinklers are installed.
- Do not let the product operate when there is standing water in the work area. For example when heavy rain forms pools of water.

### 1.5 Safety instructions for maintenance



**WARNING:** Read the warning instructions that follow before you do maintenance on the product.

- Set the product to **OFF** when you do maintenance on the product.
- Do not use a high-pressure washer to clean the product. Do not use solvents to clean the product.
- Disconnect the plug to the charging station before you clean or do maintenance of the charging station.

### 1.6 Battery safety



**WARNING:** Read the warning instructions that follow before you use the product.

- Lithium-ion batteries can explode or cause fire if disassembled, short-circuited, exposed to water, fire, or high temperatures. Handle carefully, do not dismantle, open the battery or use any type of electrical/mechanical abuse. Avoid storage in direct sunlight.

## 1.7 To lift and move the product

To safely move the product from or in the work area the product can be lifted or operated with appDrive. Refer to *appDrive on page 25*.



**WARNING:** The product must be set to OFF before you lift the product. The product is disabled when the **Main switch** is set to the 0 position.



**CAUTION:** Do not lift the product when it is parked in the charging station. It can cause damage to the charging station and/or the product. Push the **STOP** button and pull the product out of the charging station before you lift it.

1. Push the **STOP** button to stop the product.

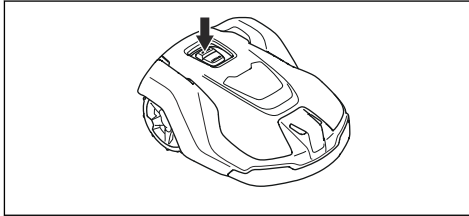

2. Set the **Main switch** to the 0 position.

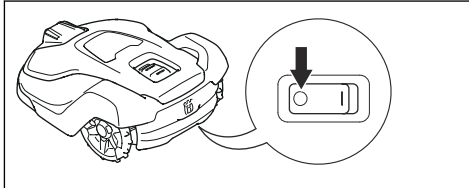

3. Lift the product by the handle with the blade disc away from your body.



---

## 2 Introduction

---

<b>Serial number:</b>
<b>Product number:</b>
<b>PIN code:</b>

The serial number and the product number are on the product rating plate and on the product carton.

- Register your product on [www.husqvarna.com](http://www.husqvarna.com). Enter the serial number of the product, the product number and the date of purchase to register your product.

### 2.1 Support

For support about the product, speak to your Husqvarna servicing dealer.

### 2.2 System description

The system contains a robotic lawn mower, a charging station and a reference station. The robotic lawn mower and reference station uses the technology with satellite signals to position the robotic lawn mower correctly, this means that boundary wires are not necessary. The reference station is stationary and sends correction data to the robotic lawn mower to get an accurate position of the robotic lawn mower. The virtual work area for the product is made in the Automower® Connect app. The product is operated and waypoints are added to make a map in the app. Refer to *System overview on page 7*.

### 2.3 Product description

**Note:** Husqvarna regularly updates the appearance and function of the products. Refer to *Support on page 6*.

The product is a robotic lawn mower. The product has a battery power source and cuts grass automatically. It continuously alternates between mowing and charging. The movement pattern of the product can be set to irregular or systematic. The virtual boundary specifies the work area where the product is allowed to operate. The satellite receiver in the product senses when it is approaching the virtual boundary. When the product hits an obstacle or approaches the virtual boundary the product selects a new direction.

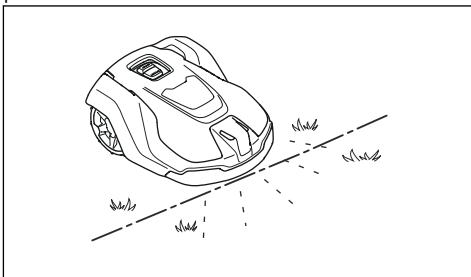

The operator selects the operation settings in the Automower® Connect app. The app shows the selected and possible operation settings, and the operation mode of the product.

#### 2.3.1 Mowing technique

The frequent cutting technique improves the grass quality and decreases the use of fertilizers. Collection of grass is not necessary.

#### 2.3.2 Find the charging station

The product operates until the battery state of charge is low or until the work area is cut, then the product starts to go to the charging station. The product uses EPOS guidance with satellite signals to find a path to the charging station. This decreases the wear on the lawn and the time to find the charging station.

#### 2.3.3 Connectivity

Husqvarna Fleet Services™ is a cloud solution that is available as an app and on the web on [www.husqvarna.com](http://www.husqvarna.com). You can add all your products to Husqvarna Fleet Services™ to get an overview and control the products. Refer to *Husqvarna Fleet Services™ on page 16*.

Automower® Connect is an app that you can use to install the product and to select the operation settings of the product. Refer to *Automower® Connect on page 17*.

## 2.4 System overview

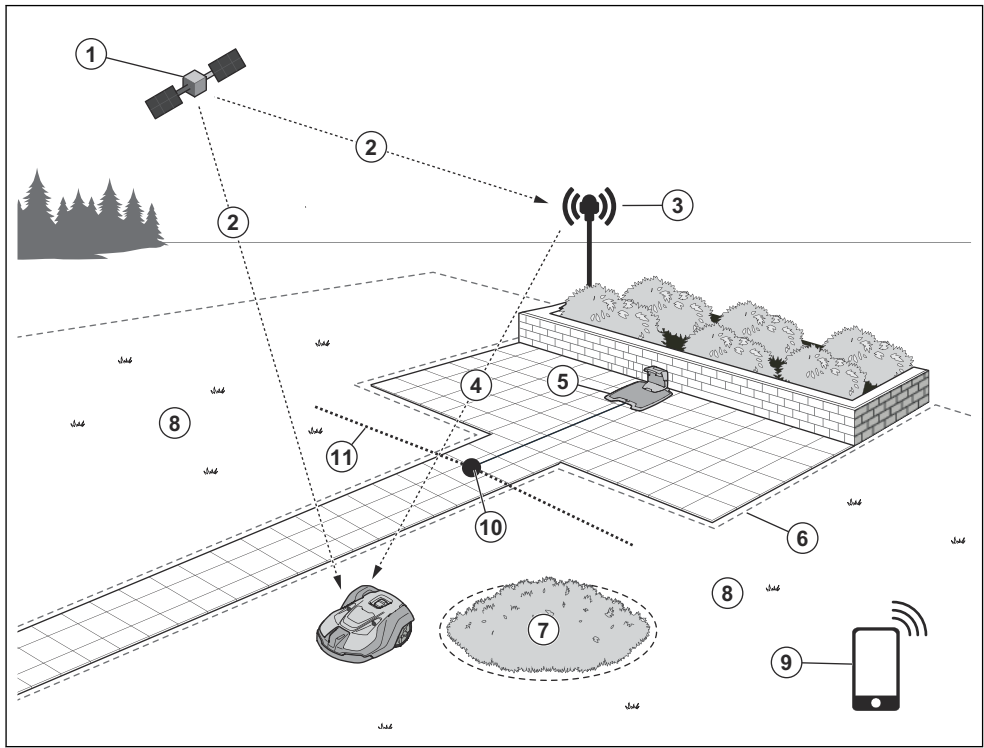

- |                                   |                               |
|-----------------------------------|-------------------------------|
| 1. Satellites                     | 7. Stay-out zone              |
| 2. Satellite signals              | 8. Work area                  |
| 3. Reference station <sup>1</sup> | 9. Mobile device <sup>2</sup> |
| 4. Correction data                | 10. Docking point             |
| 5. Charging station               | 11. Transport path            |
| 6. Virtual boundary               |                               |

<sup>1</sup> Not included.

<sup>2</sup> Not included.

## 2.5 Product overview

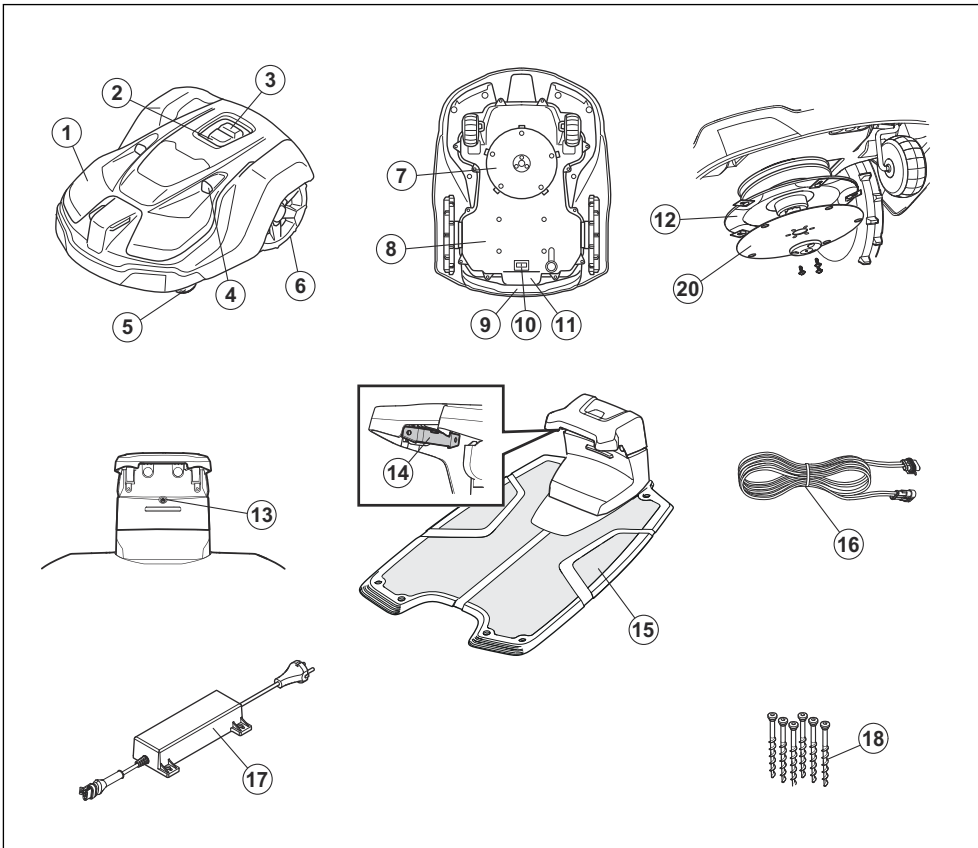

1. Body
2. LED indicator lamp of the product
3. STOP/START button
4. Ultrasonic sensors
5. Front wheels
6. Rear wheels
7. Cutting system
8. Chassis box with electronics, battery and motors
9. Handle
10. Main switch
11. Rating plate (including product identification code)
12. Blade disc
13. LED indicator lamp of the charging station
14. Contact plates
15. Charging station

16. Low-voltage cable
17. Power supply<sup>3</sup>
18. Screws to attach the charging station

## 2.6 Symbols on the product

These symbols can be found on the product. Study them carefully.

<sup>3</sup> The appearance can be different for different markets.





**WARNING:** Read the user instructions before operating the product.



**WARNING:** Disable the product before working on or lifting the product.



**WARNING:** Keep a safe distance from the product when operating. Keep your hands and feet away from the rotating blades.



**WARNING:** Do not ride on the product. Do not put your hands or feet close to or under the product.

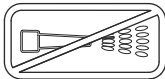

Do not use a high-pressure washer or even running water to clean the product.

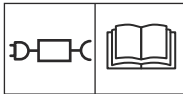

Use a detachable power supply as defined on the rating label next to the symbol.



This product complies with the applicable EU Directives.



This product complies with the applicable UK Directives.



It is not permitted to dispose this product as normal household waste. Ensure that the product is recycled in accordance with local legal requirements.



The chassis contains components which are sensitive to electrostatic discharge (ESD). The chassis must also be resealed in a professional manner. For these reasons the chassis shall only be opened by authorized service technicians. A broken seal can result in the entire or parts of the guarantee no longer being valid.

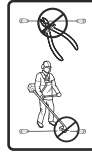

The low-voltage cable must not be shortened, extended or spliced.

Do not use a trimmer nearby the low-voltage cable. Be careful when trimming edges where the cables are placed.

## 2.7 Symbols on the battery



**WARNING:** Lithium-ion batteries can explode or cause fire if disassembled, short-circuited or handled roughly. Do not expose to water, fire or high temperature.



Read the user instructions.



Do not discard the battery into fire and do not expose the battery to a heat source.



Do not immerse the battery into water.

## 2.8 Symbols in the app



Shows the strength of the radio signal that the product receives from the reference station.

The status is *EPOS confirmed*. The product has an accurate position and direction. This is necessary to operate the product automatically and for the installation of map objects.



The status is *EPOS action is necessary*. The product has an accurate position but it is necessary to operate the product, manually or automatically, to get an accurate direction.



The status is *EPOS searching*. The product does not have an accurate position and is searching for the satellite signals and the correction data to get an accurate position.



## 2.9 General manual instructions

The following system is used in the Operator's Manual to make it easier to use:

- Text written in *italics* is a text that is in the Automower® Connect app, or is a reference to another section in the Operator's manual.
- Text written in **bold** is one of the buttons on the product or in appDrive.

---

## 3 Installation

---

### 3.1 Introduction - Installation

---



**WARNING:** Read and understand the safety chapter before you install the product.

---



**CAUTION:** Use original spare parts and installation material.

---

**Note:** Refer to [www.husqvarna.com](http://www.husqvarna.com) for more information about installation.

---

### 3.2 Primary components for installation

The installation includes the components that follow:

- Robotic lawn mower, that cuts the lawn automatically.
- Charging station, that charges the product.
- Power supply, which is connected to the charging station and a 100-240V power outlet.
- Reference station<sup>4</sup>, that receives satellite signals and sends correction data to the robotic lawn mower.
- Mobile device with the Automower® Connect app to do the installation and the settings for the product.

### 3.3 To prepare for installation

---



**CAUTION:** Holes with water in the lawn can cause damage to the product.

---



**CAUTION:** Read the installation chapter before you start the installation.

---

- Make a blueprint of the work area and include all obstacles. This makes it easier to examine where to put the charging station, the reference station, and the virtual boundaries.
- Make a mark on the blueprint where to put the charging station, the reference station, the maintenance point, the transport paths and the virtual boundaries for the work areas and stay-out zones.
- Make sure that the work area where the product operates has unimpeded sky view.
- Fill in holes in the lawn to make it level.

---

<sup>4</sup> Purchased separately.

- Cut the grass before you install the product. Make sure that the grass is maximum 10 cm / 4 in.
- 

**Note:** The first weeks after installation the sound level when the product cuts the grass can be higher than usual. The sound level decreases after some time.

---

### 3.4 To examine where to put the reference station

Read and understand the instructions about where to put the reference station. Refer to the Operator's manual for the reference station.

---

### 3.5 To examine where to put the charging station

- You can put the charging station in the work area or not in the work area. No transport path is necessary if the charging station is put in the work area (A). No transport path is necessary if the product is fully in the work area when it is at the charging station docking point. If the charging station and docking point (B) are not in the work area, you must install a transport path (C).

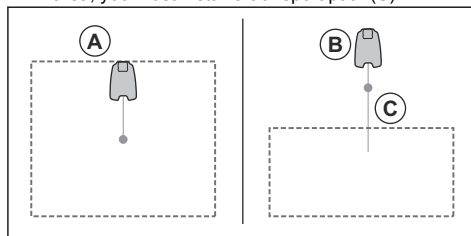

**Note:** Short reversing distance decreases the risk of track marks. A long reversing distance can be necessary to have good satellite signals at the docking point.

---

- You can put the charging station in an Automower® house.
- Put the charging station (A) where the docking point (B) has unimpeded sky view. The charging station docking point (B) is where the product stops after reversing from the charging station. The reversing distance can be set to 70-250 cm / 28-98 in. Make sure that there is minimum 6 m / 19.6 ft. (C) between objects that are higher than 1 m / 3.3 ft. around the docking point (B).

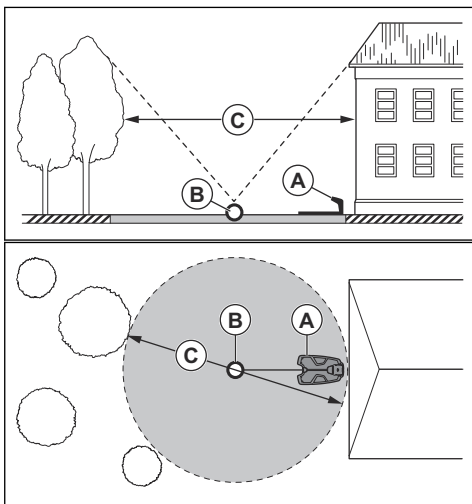

**Note:** Short reversing distance decreases the risk of track marks. A long reversing distance can be necessary to have good satellite signals at the docking point.

- If the product must not operate in a part of the docking area, put a protective wall that is minimum 15 cm / 6 in. in height. The docking area (A) is a circular area around the charging station with a radius of 3 m / 9.8 ft.

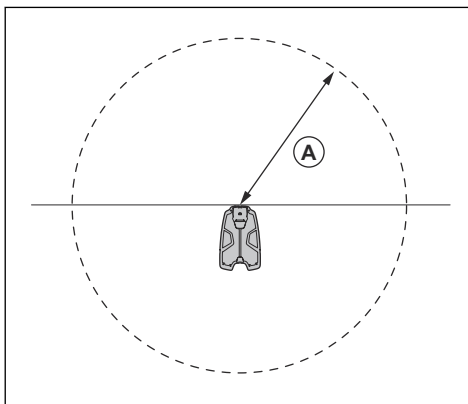
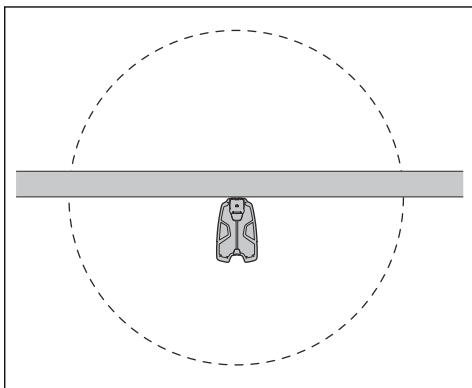

**Note:** The product uses the charging station signal to search for the charging station when it is in the docking area.

- Put the charging station near a power outlet.
- Put the charging station on a level surface.
- The baseplate of the charging station must not be bent.

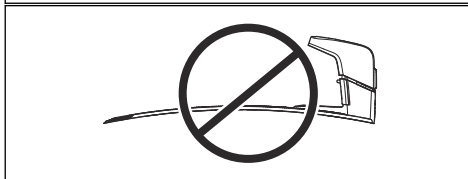
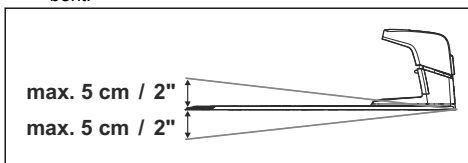

- If the work area has 2 parts separated with a steep slope, Husqvarna recommends to put the charging station in the lower section.



**CAUTION:** Do not install the charging station where there are metal objects in the ground. Metal objects can cause interference with the charging station signal.

### 3.6 To examine where to put the power supply



**CAUTION:** Make sure that the blades on the product do not cut the low-voltage cable.



**CAUTION:** Do not put the low-voltage cable in a coil or below the charging station plate. The coil causes interference with the signal from the charging station.



- Put the power supply in an area with a roof and protection from the sun and rain.
- Put the power supply in an area with good airflow.
- Use a residual-current device (RCD) with a tripping current of maximum 30 mA when you connect the power supply to the power outlet.

Low-voltage cables of different lengths are available as accessories.

### 3.7 To examine where to install the objects on the map



**CAUTION:** If the work area is adjacent to water bodies, slopes, precipices or a public road, the virtual boundary must have a protective wall. The wall must be minimum 15 cm / 6 in. in height.



**CAUTION:** Do not let the product operate on gravel.



**CAUTION:** For careful operation without noise, isolate all obstacles such as trees, roots and stones.

**Note:** Make a blueprint of the work area before you install the virtual boundaries.

- Make sure that the product can receive radio signals from the reference station in all parts of the work area. Make sure that the maximum distance between the reference station and the product is 500 m / 1640 ft.

**Note:** The maximum distance decreases if there are objects between the reference station and product.

### 3.7.1 To examine where to install the objects on the map for good satellite coverage

When the product operates it must have unimpeded sky view to use the satellite signals for navigation.

- Make sure that 90° section of the sky is unimpeded.

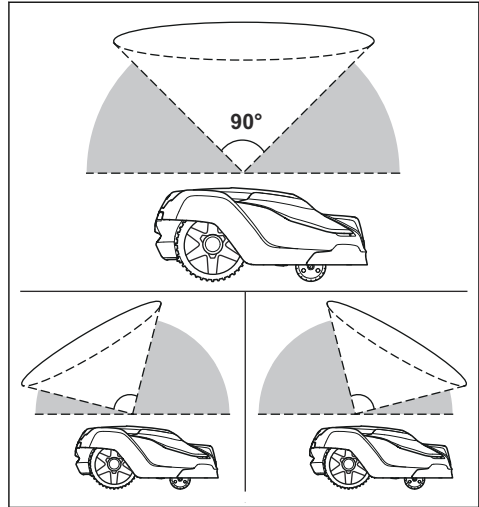

**Note:** Objects that are less than 1 m / 3.3 ft. in height (A) does not impede the satellite signals.

**Note:** Tree canopies that are less than 4 m / 13 ft. in diameter does not impede the satellite signals. If there are many small trees put together in an area, if the diameter of their canopies put together is less than 4 m / 13 ft. they do not impede the satellite signals.

- For trees with tree canopies that is more than 4 m / 13 ft. in diameter (A), make a stay-out zone (B) around the trees.

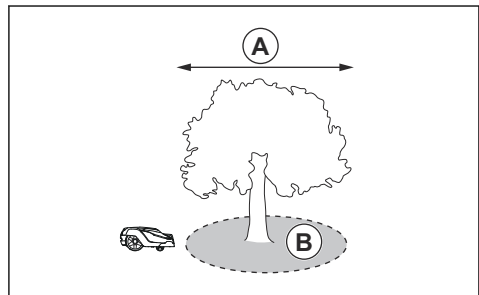

- For L-shaped objects higher than 1 m / 3.3 ft, install the virtual boundary at a minimum distance (C) of 1.5 m / 5 ft. from it.

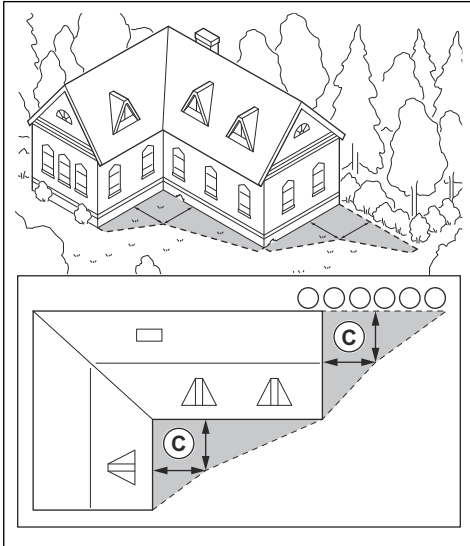

- To install virtual boundaries in an area with an U-shaped object higher than 1 m / 3.3 ft, make sure that the distance (E) is minimum 6 m / 20 ft. If the object is higher than 3 m / 10 ft., make sure that the distance (E) is twice the height of the highest object. Install the virtual boundary at a minimum distance (D) of 1.5 m / 5 ft. from the object.

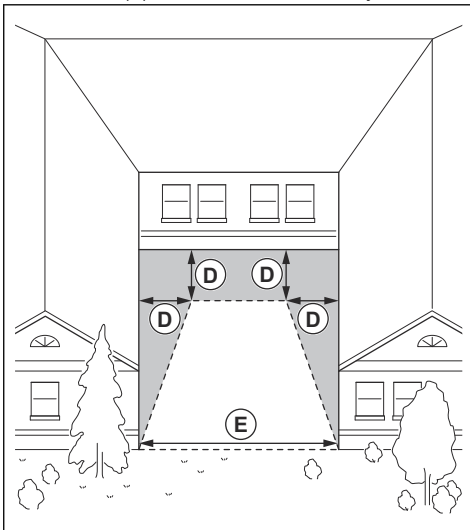

- Make sure that the width of the passage (F) between objects that are higher than 1 m / 3.3 ft. is minimum 4 m / 13.1 ft.

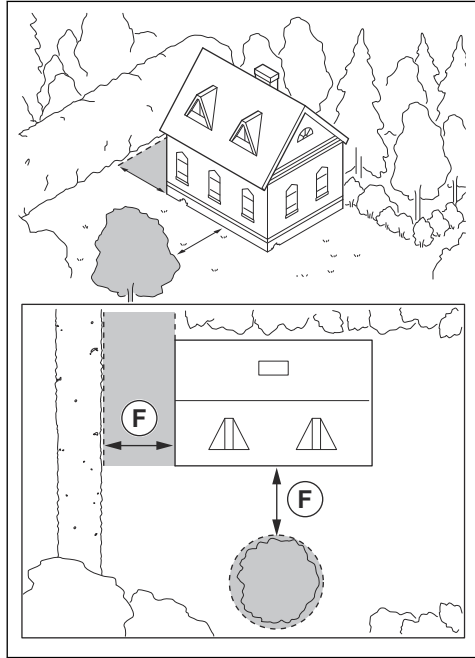

### 3.7.2 To examine where to install objects on the map in narrow passages

- Make sure that a passage between objects lower than 1 m / 3.3 ft. has a minimum width of 2 m / 6.6 ft.
- Make sure that a passage between one object lower than 1 m / 3.3 ft. and one object higher than 1 m / 3.3 ft. has a minimum width (A) of 2 m / 6.6 ft.
- Make sure that the distance between objects (B) lower than 1 m / 3.3 ft. is minimum 1 m / 3.3 ft.

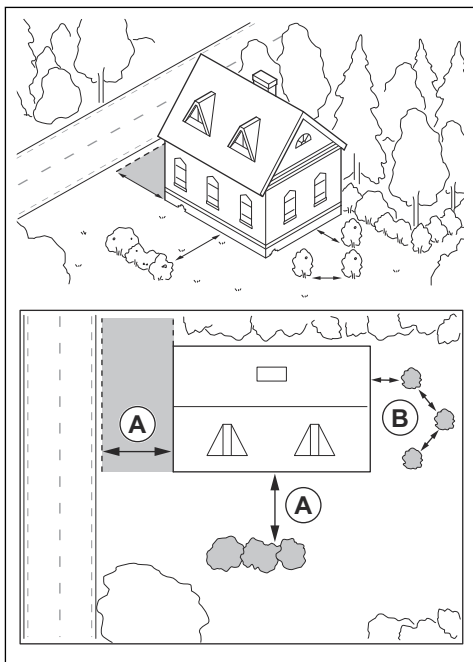

### 3.7.3 To install the map objects in a slope

The product can operate in 45% slopes. Virtual boundaries can be installed in maximum 15% slopes. The slope (%) is calculated as height for each m. Example: 10 cm / 100 cm = 10%.

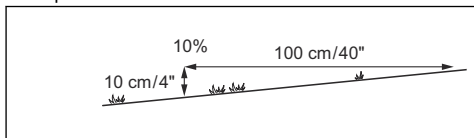

- For slopes more than 45% in the work area, isolate the slope with a stay-out zone.
- For slopes that are more than 15% along the outer edge of the lawn. For installation of the virtual boundary, operate the product with the rear wheel 5 cm / 2 in. (A) from the edge.

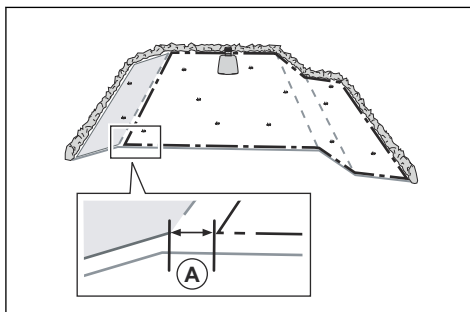

- For slopes adjacent to a public road, put a fence or a protective wall along the outer edge of the slope.
- For systematic pattern, Husqvarna recommends that the direction of the systematic pattern is straight up the slope and not parallel to it.
- Install the virtual boundaries in slopes that are maximum 15%.

### 3.7.4 To examine where to install the objects on the map for work areas with systematic pattern

- Make stay-out zones around objects that are larger than 2 x 2 m / 6.6 x 6.6 ft.
- If you have objects along the systematic pattern, make sure that the distance (A) between the objects is minimum 3 m / 9.8 ft.
- Select a different direction and pattern if the distance (A) between objects along the systematic pattern is less than 3 m / 9.8 ft. Refer to *Pattern* on page 22.

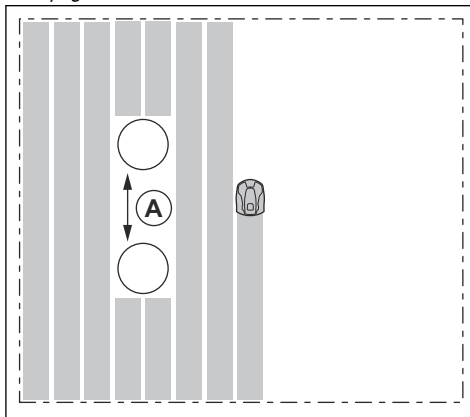

## 3.8 Installation of the product

### 3.8.1 To install the product

Do the general steps that follow to install the product:

1. Install the reference station. Refer to the Operator's manual for the reference station.
2. Install the charging station. Refer to *To install the charging station on page 16*.
3. Install the Automower® Connect app on your mobile device. Refer to *Automower® Connect on page 17*.
4. Do a pairing operation of the product and the Automower® Connect app. Do the basic settings in the start up sequence in the Automower® Connect app. Refer to *Automower® Connect on page 17*.
5. Make a map with work areas, stay-out zones, transport paths and maintenance points. Refer to *To install objects on the map on page 18*.
6. Use Automower® Connect app to do settings for the product. Refer to *Settings on page 21*.

### 3.8.2 Installation tools

- Hex key, 8 mm. Included in the carton.

### 3.8.3 Installation of the charging station

Read and understand the instructions about the charging station. Refer to *To examine where to put the charging station on page 11*.



**CAUTION:** Do not make new holes in the charging station plate.



**CAUTION:** Do not put your feet on the baseplate of the charging station.



**WARNING:** Make sure that the plugs of the low-voltage cable and the power supply unit are clean and dry before you connect them.

When you connect the power supply, only use a power outlet that is connected to a residual-current device (RCD).

#### 3.8.3.1 To install the charging station

1. Put the charging station in the selected area.
2. Attach the charging station to the ground with the supplied screws.
3. Connect the low-voltage cable to the charging station.
4. Put the power supply at a minimum height of 30 cm / 12 in. Refer to *To examine where to put the power supply on page 12*.

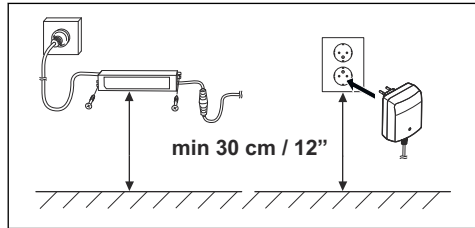

5. Connect the power supply cable to a 100-240V power outlet.
6. Put the low-voltage cable in the ground outside the work area. Use stakes or bury the cable.
7. Put the product in the charging station to charge the product.

#### 3.8.3.2 To do a visual check of the charging station

1. Make sure that the indicator LED lamp on the charging station has a green light.

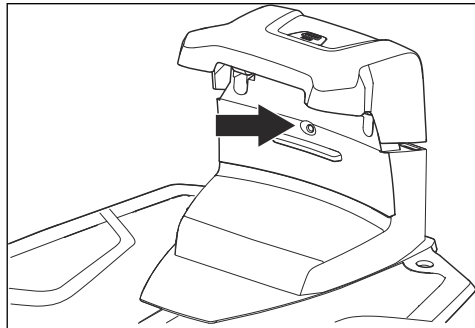

2. If the indicator LED lamp does not have a green light, do a check of the installation. Refer to *To install the charging station on page 16* and *LED indicator lamp on the charging station on page 38*.

### 3.8.4 Installation of the reference station

Install the reference station according to the instructions in the Operator's manual for the reference station.

### 3.8.5 Husqvarna Fleet Services™

Husqvarna Fleet Services™ is a cloud solution that gives the commercial fleet manager an overview of all products. It also gives the fleet manager the possibility to control all products remotely. Husqvarna Fleet Services™ is available as a web service and as an app. When you use the Husqvarna Fleet Services™ app you will be redirected to the Automower® Connect app. For more information about Husqvarna Fleet Services™, refer to [www.husqvarna.com](http://www.husqvarna.com).



**Note:** All countries do not support cellular connection because of regional specified cellular systems. The included lifetime service only applies if there is a third part sub-supplier of 2G/4G available in the operational area.

### 3.8.6 Automower® Connect

Automower® Connect is a free app for your mobile device. Use the app for installation, settings and operation of your product. You can also find more information for example about alarm and statistics in the Automower® Connect app.

The app gives 2 modes of connectivity: Long-range cellular connectivity and Short-range Bluetooth® connectivity.

### 3.8.7 To do the basic settings

When the product is set to ON for the first time, there are some basic settings to do before the product can start to operate.

1. Download the Husqvarna Fleet Services™ app and Automower® Connect app to your mobile device.
2. Log on to the Husqvarna Fleet Services™ app.
3. Set the product to ON.
4. Start Bluetooth® on your mobile device.

**Note:** The Bluetooth® pairing operation mode of the product is enabled for 3 minutes. If the pairing operation between the product and the mobile device is not completed correctly, push the Bluetooth® button on the product to enable Bluetooth® again.

5. Select *Add robotic mower* in the app to add your product and follow the instructions in the app.
6. Do a pairing operation of the product and the reference station.
7. Do a pairing operation of the product and the charging station. Select to enable GeoFence or not and set the reversing distance.

### 3.8.8 Installation of the map objects

Read and understand the instructions about where to install the map objects. Refer to *To examine where to install the objects on the map on page 13*.

On the map you can install the objects that follow in the app:

- *Work areas (A)*
- *Stay-out zones (B)*
- *Transport path (C)*
- *Charging station (D)*
- *Maintenance point (E)*
- *Reference station (F)*

- *Work area (Secondary area) (G)*

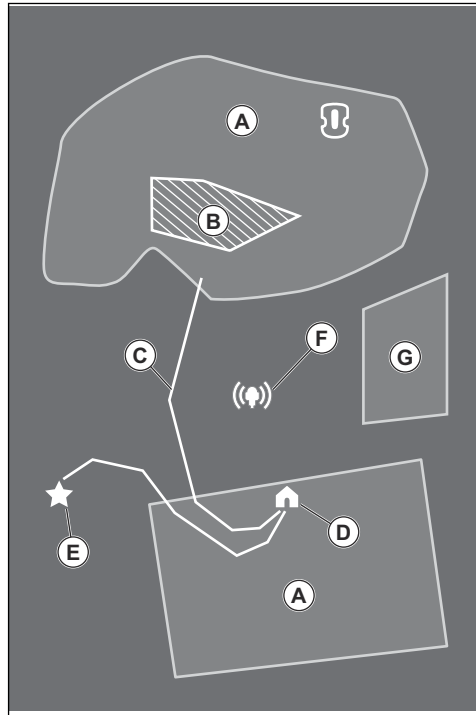

For a complete map installation, you must install a work area and a charging station on the map.

A work area is specified by virtual boundaries. Maximum 20 work areas and secondary areas can be installed on a map.

There are two types of work areas:

- A work area that has a charging station in it or connected to it with a transport path where the product operates automatically.
- A secondary area is a work area with no charging station and no transport path. The product must be moved manually to and from the work area.

A transport path is a specified path between the docking point in front of the charging station and a work area.

The product can operate automatically in this path, but does not cut grass. A transport path can temporarily be enabled and disabled in the app.

Stay-out zones can be made if there are areas where the product must not operate. A stay-out zone is specified by virtual boundaries. Stay-out zones can temporarily be enabled and disabled in the app.

A maintenance point is a specified position where the product can be parked at. This can for example be used for a service point where maintenance of the product

is done. The maintenance point is connected to the docking point with a path.

To install objects on the map, operate the product with the appDrive installation to add waypoints on the map. Refer to *To install objects on the map on page 18*.

### 3.8.8.1 To install objects on the map

The waypoints (A) are positions that makes the virtual boundaries and paths (B). The lines are straight between the waypoints. Add a number of waypoints to make smooth curves. It is recommended to use as few waypoints as possible. For each work area and the related stay-out zones and transport path the total maximum number of waypoints are . Husqvarna recommends to add maximum waypoints for the complete installation of the map. You can adjust the positions of the waypoints in the app after the installation of the map.

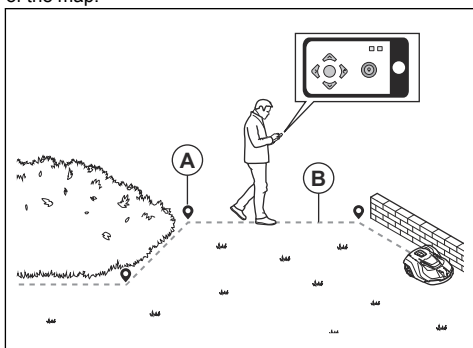

**CAUTION:** Do not lift and move the product between the waypoints when you install the map objects. Use appDrive for a correct installation.

**Note:** The position of the waypoint when you install a work area or a stay-out zone is in the front left corner of the product.

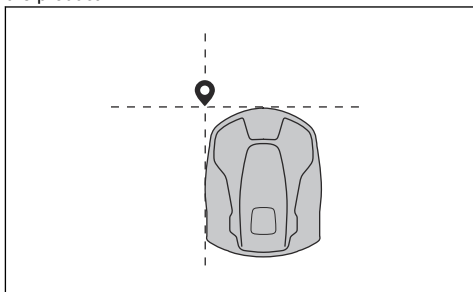

**Note:** The position of the waypoint when you install a transport path or a path to a maintenance point is in the middle of the product between the drive wheels.

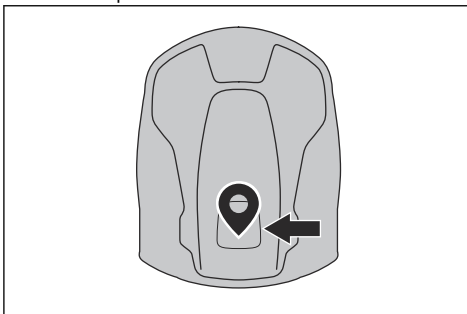

- Make sure that you are near the product and connected to the product with the app with Bluetooth®.
- Make sure that the status is *EPOS confirmed* in the appDrive.
- Make sure that the radio signal strength from the reference station is good. The symbol for the strength of the radio signal must be fully filled.
- Select the object you want to install and use the buttons in the appDrive installation to operate the product.
- Use the **up** button (A) to move the product forward.
- Use the **down** button (B) to move the product rearward.
- Use the left **arrow** button (C) to rotate the product to the left.
- Use the right **arrow** button (D) to rotate the product to the right.
- Use the **center** button (E) as a joystick to move and rotate the product in any direction.
- Use the **waypoint** button (F) to add a waypoint in the map.

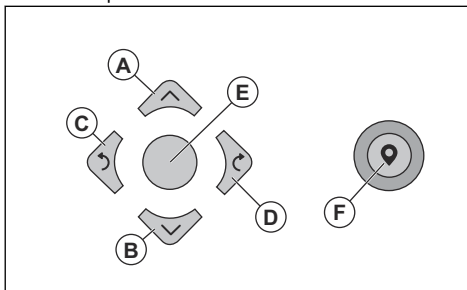

**Note:** Walk 2-3 m / 6.5-9.8 ft. behind the product when you operate the product with appDrive.

### To make a work area

Minimum 3 waypoints are necessary to make a work area.

- Operate the product clockwise around the boundary of the work area.
- Add waypoints on the map. Add the waypoints minimum 3 cm / 1 in. from obstacles.

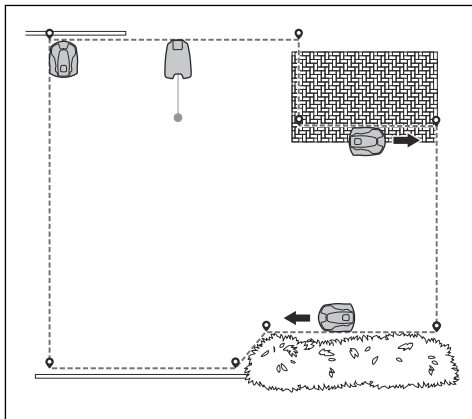

- Add a waypoint to make the product cut the grass at the edge between the lawn and the stone path. Make sure that you straddle the edge of the lawn and the stone path when you add a waypoint. The product can straddle the edge if the height of the stone path is maximum 1 cm / 0.4 in. in relation to the lawn.

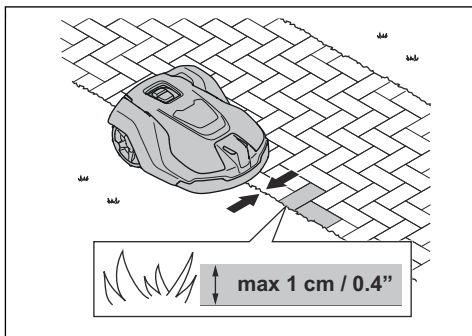

- Add the waypoint at the outer corner to install the virtual boundary around a corner.

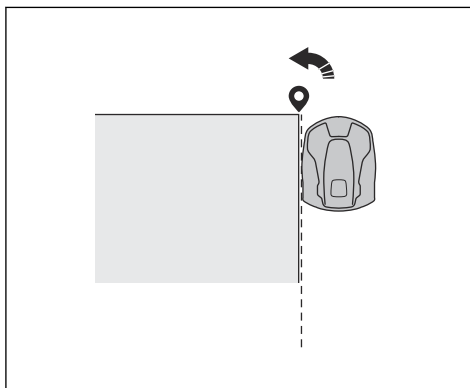

- Do not set waypoints that make a virtual boundary go across itself in the same work area.
- Save the work area to automatically connect the first and last waypoint with a virtual boundary.

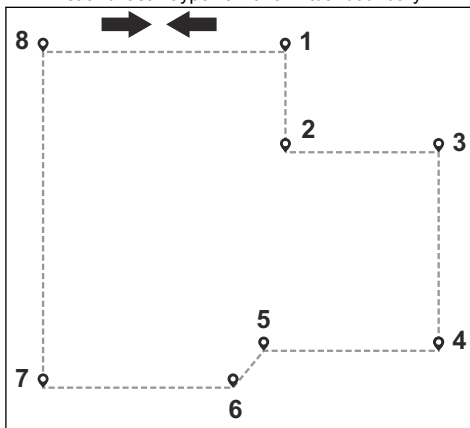

### To make a stay-out zone

Minimum 3 waypoints are necessary to make a stay-out zone.

- Operate the product counterclockwise around the boundary of the stay-out zone.
- Add waypoints on the map. Add the waypoints minimum 3 cm / 1 in. from obstacles.
- Do not set waypoints that make a virtual boundary go across itself in the same stay-out zone.
- Save the stay-out zone to automatically connect the first and last waypoint with a virtual boundary.

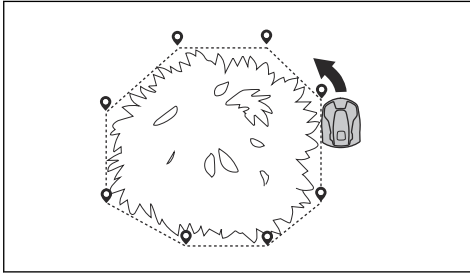

#### To make a transport path

- Operate the product and add waypoints on the map to install a transport path. Start in a work area minimum 1 m / 3.3 ft. from the virtual boundary.
- Do not install a transport path across a stay-out zone.
- Do not set waypoints that make the transport path go across the same transport path.
- Operate the product and add waypoints to connect the transport path to the docking point.
- Save the transport path to automatically connect the last waypoint to the docking point.
- Set the corridor width (A) for the transport path. The corridor width can be set to 2-5 m / 6.6-16.4 ft.

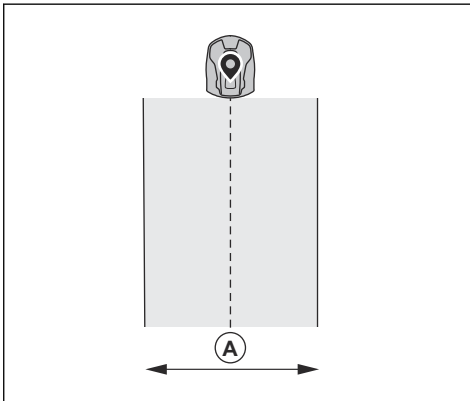
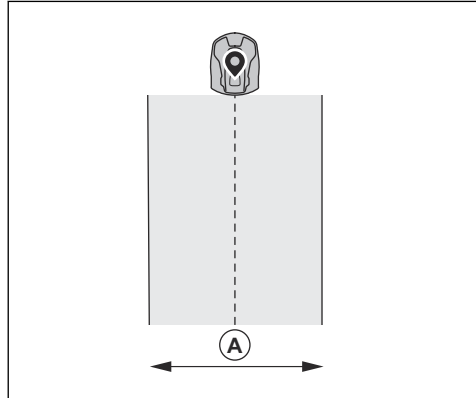

#### To make a maintenance point

- Operate the product and add waypoints on the map. Start to add waypoints at the position where you install the maintenance point. The first waypoint specifies the maintenance point.
- Operate the product and add waypoints to make a path to the charging station.
- Save the maintenance point to automatically connect the last waypoint to the docking point.
- Set the corridor width (A) for the maintenance point. The corridor width can be set to 2-5 m / 6.6-16.4 ft.

## 4 Settings

The product has factory settings but the settings can be adapted to each work area.

### 4.1 Schedule



In *Schedule* menu you can change the schedule settings for the product. You can set separate schedule settings for each work area. *Secondary areas* cannot be scheduled.

The schedule function controls which hours the product is permitted to operate. When the product does not operate, it is parked in the charging station. You can see which hours and days the product operates in the schedule overview in the app.

Quality	Operation frequency
Pro sport quality	Each day
Pro quality	Each second day
Regular quality	Each third day

There are 3 different quality levels that you can select which decides the cutting frequency:

- Pro sport quality: Used for everyday care of sports fields or golf courses at low cutting height. For a well managed, lush and dense turf.
- Pro quality: For facilities with high demands on grass quality. Medium grass height and normal dense quality of turf. The grass is cut every second day.
- Regular quality: For turf with low level of grass growth. High cutting height and normal to low dense quality of turf. The grass is cut two times per week.

The table shows the approximate number of hours the product must operate each day for a specified area dimension.

	Systematic pattern		
	Pro sport quality	Pro quality	Regular quality
1000 m <sup>2</sup> / 0.25 acre	5 h	2.5 h	2 h
2500 m <sup>2</sup> / 0.6 acre	12 h	6 h	4 h
5000 m <sup>2</sup> / 1.25 acre	24 h	12 h	8 h
7500 m <sup>2</sup> / 1.85 acre	-	18 h	12 h
10000 m <sup>2</sup> / 2.5 acre	-	24 h	18 h
15000 m <sup>2</sup> / 3.7 acre	-	-	24 h

	Irregular pattern		
	Pro sport quality	Pro quality	Regular quality
1000 m <sup>2</sup> / 0.25 acre	7 h	5 h	4 h
2000 m <sup>2</sup> / 0.5 acre	14 h	10 h	8 h
3500 m <sup>2</sup> / 0.9 acre	24 h	17 h	14 h
5000 m <sup>2</sup> / 1.25 acre	-	24 h	20 h
6000 m <sup>2</sup> / 1.5 acre	-	-	24 h

If you have work areas with systematic pattern and works areas with irregular pattern, set different hours for each work area. Husqvarna recommends to set the product to each day start to cut the work areas that has systematic pattern. Set the product to cut the work areas that has irregular pattern after the work areas with systematic pattern are cut. The product cuts the work area with systematic pattern until all of the work area is cut. The product cuts the work area with irregular pattern until the schedule is complete.

## 4.2 Cutting height



The cutting height is set individually for each work area. The cutting height can be set to 20-60 mm / 0.8-2.4 in.

## 4.3 Pattern



The settings for the pattern is set for each work area. You can do these settings:

- Set the pattern for how the product operates.
- Set the direction of the pattern.
- Set the type of the *Border mowing*. With *Fixed border mowing* the product always operates in the same paths to keep a sharp border around the work area. With *Variable border mowing*, the product operates in different paths to decrease the risk of track marks along the virtual boundary.
- Set a pattern that includes a number of directions in work areas that includes many obstacles and stay-out zones.

Husqvarna recommends to use systematic pattern on large and open work areas. The systematic pattern can make track marks on the lawn. If you use systematic pattern on a work area with obstacles, make stay-out zones around obstacles and use a pattern with many directions for a satisfactory cutting result.

Husqvarna recommends to use irregular pattern if the work area is complex and has many obstacles.

## 4.4 Operation



In the Operation's menu it is possible to change the settings of the *Weather timer*, *ECO mode* and *Spiral cutting*.

### 4.4.1 Spiral cutting

If the product enters an area where it senses the grass is longer than average, it can change the movement pattern to *Spiral cutting*. This means that the product mows in a spiral pattern to faster cut the area with longer grass. It is possible to set the intensity of the *Spiral cutting*. *Very low / Low* intensity means that *Spiral cutting* begins less often. *High / Very high* intensity means that *Spiral cutting* begins more often.

---

**Note:** *Spiral Cutting* does not start in slopes steeper than 15%.

---

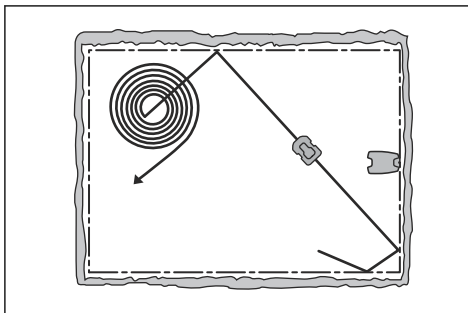

### 4.4.2 Weather timer

*Weather timer* automatically adjust the cutting time to the growth of the grass. The product is not permitted to operate more than the schedule settings.

---

**Note:** When using *Weather timer*, it is recommended to make as much operating time as possible available for *Weather timer*. Do not restrict the schedule more than necessary.

---

The first operation of the day is set by the schedule settings. The product always complete 1 mowing cycle, and then *Weather timer* selects if the product will continue to operate or not.

---

**Note:** *Weather timer* is reset if the product does not operate for more than 50 hours, or if a *Reset of all user settings* is done. *Weather timer* is not changed if a *Reset of schedule settings* is done.

---

### 4.4.3 ECO mode

If *ECO mode* is enabled, it switches off the signal in the charging station, when the product is parked or is charging.

---

**Note:** Use *ECO mode* to save energy and prevent interference with other equipment, for example hearing loops or garage doors.

---

---

**Note:** To start the product manually in the work area, push the **STOP** button before you remove the product from the charging station. If not, the product cannot park at the charging station.

---

## 4.5 Accessories



Settings for accessories mounted on the product can be made in this menu.

### 4.5.1 Headlights

There are 4 different headlight settings that control when the headlights are on:

- *Always on*
- *Evening only (19:00-00:00)*
- *Evening and night (19:00-07:00)*
- *Always off*

The headlights can be set to *Strobe amber light* or to *Amber light*. The headlights can also be set to flash if there is an error.

---

**Note:** Husqvarna recommends to use the headlights at night time.

---

### 4.5.2 To avoid collisions with the Automower® house

When this option is enabled, the wear on the product and the Automower® house is reduced, but it can result in more uncut grass around the charging station.

## 4.6 General (Bluetooth® only)



This function is used to set time and date, or to reset to default settings.

### 4.6.1 Time & date

The time and date can be changed manually, or by using the time and date from the mobile device.

### 4.6.2 Reset to factory settings

The user settings can be reset to factory settings. All map objects and the schedules will be deleted.

---

**Note:** *PIN code, Loop signal, Messages and Date & Time* will not be reset.

---

## 4.7 Security (Bluetooth® only)



The security settings controls the PIN code, the GeoFence and other security functions. The correct PIN-code must be entered to get access to the *Security* menu.

### 4.7.1 New loop signal

The loop signal is randomly selected to create a unique link between the product and the charging station. In rare cases, there may be a need to generate a new signal, for instance if 2 adjacent installations have a very similar signal.

### 4.7.2 Change PIN code

You can change the PIN code. Make a note of the new PIN code in Memo. Refer to *Introduction on page 6*.

### 4.7.3 Theft protection

In the *Theft protection* menu it is possible to set the alarm duration and also what events should trigger the alarm. The factory setting is to require PIN code and the alarm duration is 1 min.

#### 4.7.3.1 Require PIN code

This function means that the product cannot be operated or controlled after the **STOP** button has been pushed without first entering the correct PIN code. If the incorrect PIN code is entered 5 times, the product is locked for a time. The lock is extended for each new incorrect try.

#### 4.7.3.2 Alarm duration

There is a possibility to set how long the alarm signal should last. A setting between 1 and 10 minutes is possible.

#### 4.7.3.3 STOP button pressed

If the alarm *"STOP button pressed"* is enabled, the alarm goes off if someone presses the **STOP** button and the PIN code is not entered within 30 seconds.

#### 4.7.3.4 Carried away

If the alarm *Carried away* is enabled, the product senses unexpected motions, and the alarm goes off.

### 4.7.4 GeoFence

GeoFence is a GPS-based theft protection that makes a virtual fence for the product. If the product is more than a set distance away from the center position the product will be disabled and an alarm will start. The center position sets to the current position of the product when GeoFence is enabled. The PIN code is necessary to stop the alarm and to start the product again. The

GeoFence is only enabled when the product is set to ON.

## 4.8 Automower® Connect (Bluetooth® only)



In *Automower® Connect* you can enable or disable the Automower® Connect module. You can also see the signal strength, connectivity status, initiate new pairing or remove the product from the paired accounts.

## 4.9 Messages

In this menu the previous fault and information messages can be found. For some of the messages, there are tips and advice to help to rectify the fault.

If the product is disrupted in any way, for example it is trapped or the battery is low, a message is saved relating to the disruption and the time it happened.

If the same message is repeated several times, this may indicate that an adjustment to the installation or the product is required. Refer to *Installation on page 11*.

## 4.10 Download firmware over the air (Firmware over the air FOTA)

The product has a function that automatically downloads new firmware. When a new firmware is available, a notification shows in the app where you can select to install the new firmware. In the factory setting this function is enabled.



## 5 Operation

### 5.1 Main switch



**WARNING:** Read and understand the safety chapter before you use the product.

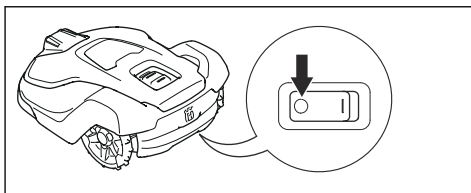

- Set the **Main switch** to the *1* position to start the product.
- Set the **Main switch** to the *0* position to set the product to OFF.

### 5.2 To start the product

1. Push the **STOP** button on the product.
2. Set the **Main switch** to the *1* position.
3. Open the Automower® Connect app.
4. Enter the PIN code.
5. Select an operating mode in the app. Refer to *To select operation mode Start* on page 25.
6. Push the **START** button on the product.
7. Select an operating mode in the app.

### 5.3 To select operation mode Start

1. Open the app on your mobile device.
2. Select *Start* and select an operation mode: *Resume Schedule*, *appDrive* or *Select work area*.

#### 5.3.1 Resume Schedule

The product will continue to operate on the scheduled work area where it cuts the grass and charges automatically.

#### 5.3.2 appDrive

Use the appDrive to operate the product manually.

##### 5.3.2.1 To operate the product with appDrive

Use the buttons to operate the product:

- Use the **up** button (A) to move the product forward.
- Use the **down** button (B) to move the product rearward.
- Use the left **arrow** button (C) to rotate the product to the left.

- Use the right **arrow** button (D) to rotate the product to the right.
- Use the **center** button (E) as a joystick to move and rotate the product in any direction.

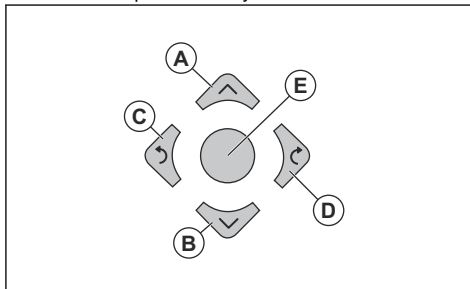

**Note:** Walk 2-3 m / 6.5-9.8 ft. behind the product when you operate the product with appDrive.

#### 5.3.3 Select work area

This function lets the product temporarily operate in a selected work area. You can select a time limit for this function. After that time period, the product continues to operate as set in the schedule.

##### 5.3.3.1 Secondary area

For the product to operate in a secondary area, you must move the product manually to and from the secondary area. The product cuts for a selected period of time or until the battery is empty.

### 5.4 Operating mode - Park

When you select *Park* in the app you can select the operation selections that follow:

- *Park until further notice*
- *Select duration*

#### 5.4.1 Park until further notice

The operation mode *Park* means that the product goes back to the charging station where it stays until a new operation mode is selected and the **START** button is pushed.

#### 5.4.2 Select duration

The product goes back to the charging station and stays for the selected park duration. Use the operation selection to temporary stop an ongoing mowing cycle and let the product to stay in the charging station.

#### 5.4.3 Operating mode - Pause

When selecting *Pause* in the Automower® Connect app, the product stop the current activity and pause. The

product is paused until either *Park* or *Start* is selected in the Automower® Connect app.

## 5.5 To stop the product

1. Push the **STOP** button on top of the product.

The product stops and the cutting motor stops.

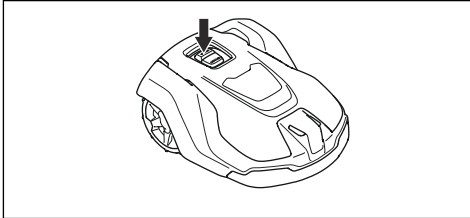

**Note:** When you push the **START** button again, the product continues to operate in the same operating mode as before.

## 5.6 To set the product to OFF

1. Push the **STOP** button.
2. Connect the product with Bluetooth® short-range in the app.

**Note:** The product cannot be set to OFF if it is not connected to the app with Bluetooth®.

3. Set the **Main switch** to the 0 position.

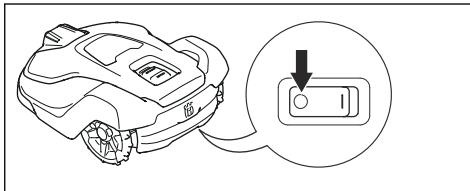

## 5.7 To charge the battery

When the product is new or after long-term storage, the battery can be empty. Charge the battery before you start the product.

1. Set the **Main switch** to the 1 position.
2. Put the product into the charging station until the charging plates touch the contact plates.
3. Do a check that the product charges in the Automower® Connect app.

## 6 Maintenance

### 6.1 Introduction - maintenance



**WARNING:** Set the product to OFF before you do maintenance on the product.



**WARNING:** Use protective gloves.

For better operation and lifetime of the product, make sure to clean the product regularly and replace worn parts.

When the product is new, examine the blade discs and blades each week. If the wear is low, you can increase the interval for the next time you examine the blade discs and blades. Examine the blade discs and the blades more regularly if there is much wear.

It is important that the blade disc rotates easily and that the edges of the blades are not damaged. The usual lifetime of the blades are 2 to 5 weeks. The conditions that follow can increase or decrease the lifetime of the blades:

- Operation time and dimension of the work area.
- Length and thickness of the grass.
- Soil, sand and use of fertilizers.
- Objects such as cones, tools, stones and roots in the work area.

**Note:** The cut result can be unsatisfactory if the blades are blunt. Refer to *Replacement of the blades on page 29* on how to replace the blades.

### 6.2 Maintenance schedule

The maintenance schedule shows how to do servicing and maintenance on the product. Follow the maintenance schedule for a better operation and to increase the lifetime of the product.

X = The instructions are given in this operator's manual.

O = The instructions are not given in this operator's manual. Speak to your approved servicing dealer.

To prepare	Weekly	Every year	Every third year
Clean the product. Refer to <i>Clean the product on page 28</i> .	X		
Examine the product for damage and wear.	X		
Do an update of the firmware.		O	
Do a check of the servicing messages for recommended upgrades.		O	
<b>Servicing</b>			
Examine the blades and replace the blades and blade screws if it is necessary. Refer to <i>Replacement of the blades on page 29</i> .	X		
Examine and polish the contact plates on the charging station.		X	
Examine and polish the charging plates on the product.		X	
Charge the battery fully before you put the product into storage. Refer to <i>To charge the battery on page 26</i> .		X	
Examine the wheels for wear.		O	
Examine and clean the collision columns. Do a check of the tightening torque on the front and rear collision columns.		O	
Make sure that the product is docking and charging correctly.		O	
Examine the cable and connector to the charging plates on the body of the product.		O	

To prepare	Weekly	Every year	Every third year
Examine the rubber grommets on the chassis to make sure that it is sealed correctly.		○	
Examine the skid plate and skid plate bearing.		○	
Examine the rubber bellows in the cutting height adjustment system.		○	
Examine the rubber bellows for the collision columns.		○	
Replace the rubber bellows for the collision columns.			○
Examine and clean the airflow filter.		○	
Replace the airflow filter.			○
Do a check of the tightening torque of chassis screws.		○	
Open the chassis and replace all sealing strips.			○
<b>Last step</b>			
Use a software service tool to do a function test of the functions of the product.		○	

### 6.3 Clean the product

Husqvarna recommends to use a special cleaning and maintenance kit, available as an accessory. Speak to your Husqvarna representative for more information.



**CAUTION:** Do not use a high-pressure washer to clean the product and the charging station. Do not use solvents for cleaning.

#### 6.3.1 To clean the chassis and blade disc

Examine the blade disc and blades weekly.

1. Set the **Main switch** to the 0 position.
2. Put the product onto its side.
3. Make sure that the blades are not damaged and that the blades and blade disc can rotate freely.
4. Clean the blade disc and chassis with a brush.

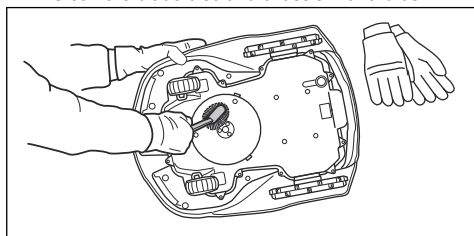

#### 6.3.2 To clean the chassis

- Clean the bottom of the chassis with a brush or a moist cloth.

#### 6.3.3 To clean the wheels

The product does not operate satisfactorily in slopes if the wheels are blocked with grass.

- Use a soft brush to clean the wheels.

#### 6.3.4 To clean the body of the product

- Use a moist cloth and a weak soap solution to clean the body of the product.

#### 6.3.5 To clean the charging station



**WARNING:** Disconnect the power supply from the power outlet before maintenance, or when you clean the charging station or power supply.



**CAUTION:** Do not use a high-pressure washer or running water to clean the charging station.

**Note:** The product cannot enter the charging station if there are objects in the charging station. Clean the charging station regularly.

- Remove grass, twigs and other objects from the charging station.

## 6.4 Replacement of the blades



**WARNING:** Husqvarna can only guarantee safety if you use Husqvarna original blades with the embossed crowned H-mark logotype.

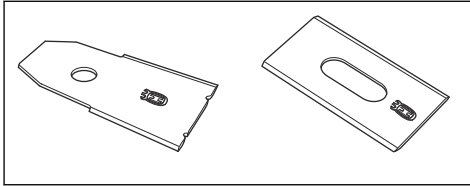

**WARNING:** You must replace the screws when you replace the blades. The used screws can wear quickly and make the blade come loose, this can cause serious injury.

Replace worn or damaged blades for a safe operation. Replace the blades regularly for a satisfactory cut result and a low energy use. All 5 blades and screws must be replaced at the same time to get a balanced cutting system.

### 6.4.1 To replace the blades

1. Push the **STOP** button.
2. Set the **Main switch** to the 0 position.

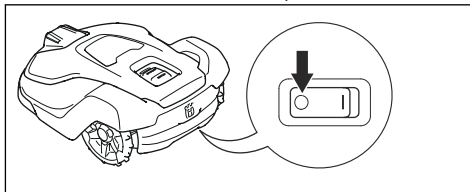

3. Put the product with the blade disc up on a soft and clean surface.
4. Rotate the skid plate until its holes align with the screws for the blade.
5. Remove the 5 screws with a screwdriver.

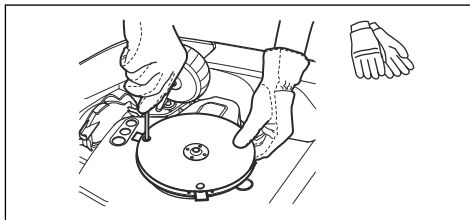

6. Remove the 5 blades.
7. Attach 5 new blades and screws.

8. Make sure that the blades can pivot freely.

## 6.5 Replace the wheel brushes

The wheel brushes on the product removes grass from the wheels of the product. Examine the wheel brushes regularly and replace them when they are worn. Husqvarna recommends to replace the wheel brushes each 5-10 weeks.

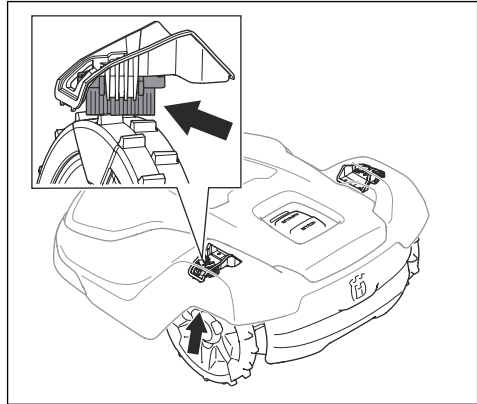

## 6.6 Battery



**CAUTION:** Charge the battery fully before you put the product into storage. If the battery is not fully charged it can cause damage to the battery.

If the operating time of the product is shorter than usual between charges, this means that the battery is at the end of its life cycle. Replace the battery to extend the operating time.

**Note:** The battery life is related to the length of the season and how many hours a day the product operates. A long season or many hours of operation a day means that the battery must be replaced more regularly.

## 6.7 Winter service

Take your product to your Husqvarna central service for service prior to winter storage. Regular winter service will maintain the product in good condition and create the best conditions for a new season without any disruptions.

Service usually includes the following:

- Thorough cleaning of the body, the chassis, the blade disc and all other moving parts.
- Testing of the product's function and components.

- Checking and, if required, replacing wear items such as blades and bearings.
- Testing the product's battery capacity as well as a recommendation to replace battery if necessary.
- If new firmware is available, the product is updated.

---

## 7 Troubleshooting

---

### 7.1 Introduction - troubleshooting

All messages can be found in the *Messages* menu in Automower® Connect. More suggestions for steps to take in the event of malfunction or symptoms can be found on [www.husqvarna.com](http://www.husqvarna.com).

---

**Note:** The *Messages* menu is only available for short-range connectivity (Bluetooth®).

---

### 7.2 Fault messages

The fault messages in the table below are shown in the Automower® Connect app. Speak to your Husqvarna representative if the same message shows frequently.

Message	Cause	Action
<i>Cutting system blocked</i>	The blade disc is blocked by grass or other objects.	Examine the blade disc and remove the grass or other object.
	The blade disc is in water.	Move the product and prevent the collection of water in the work area.
	The grass is high and thick.	Adjust the cutting height to the height of the grass. Adjust the schedule settings to increase the operation time.
<i>Trapped</i>	The product is behind a number of obstacles in a small area.	Examine the area and remove the obstacles which make it hard for the product to move away from this location.

Message	Cause	Action
<i>No loop signal</i>	The power supply or the low-voltage cable for the charging station is not connected.	If the LED indicator on the charging station is out, it shows that there is no power. Examine the power outlet connection and the residual-current device. Make sure that the low-voltage cable is connected to the charging station.
	The power supply or the low-voltage cable for the charging station is damaged.	Replace the power supply or low-voltage cable.
	<i>ECO mode</i> is enabled and the LED indicator of the charging station flashes green. The product was started manually in the work area but the <b>STOP</b> button was not pushed before the product was moved from the charging station. The charging station signal is disabled and the product cannot enter the charging station. Refer to <i>ECO mode on page 22</i> .	Put the product in the charging station. Start the product. Refer to <i>To start the product on page 25</i> .
	The product does not find the loop signal from the charging station.	Put the product in the charging station and make a new loop signal. Refer to <i>New loop signal on page 23</i> .
	The charging station is not installed correctly.	Install the charging station according to the instruction. Refer to <i>To install the charging station on page 16</i> .
	Interference from metal objects such as fences, reinforcement steel or buried cables near the charging station.	Change the position of the charging station.
<i>Outside work area</i>	The work area slopes too much by the virtual boundary.	Make sure that the virtual boundary is installed correctly. Refer to <i>Installation of the map objects on page 17</i> .
	The transport path or the path to the maintenance point slopes too much.	Make sure that the transport path is installed correctly. Refer to <i>To make a transport path on page 20</i> .
	The product can not find the correct charging station signal because of interference with a loop signal from a different product installation nearby.	Put the product in the charging station and make a new loop signal. Refer to <i>New loop signal on page 23</i> .
	Interference from metal objects such as fences, reinforcement steel or buried cables near the charging station.	Change the position of the charging station.



<b>Message</b>	<b>Cause</b>	<b>Action</b>
<i>Empty battery</i>	The product cannot find the charging station.	The product has no accurate position and cannot find the charging station. There is an obstacle that prevents the product to find the charging station.
	The battery is at the end of its life cycle.	Replace the battery. Refer to <i>Battery on page 29</i> .
	The antenna of the charging station is defective.	If the LED indicator on the charging station flashes red, the antenna of the charging station is defective. Speak to your approved servicing dealer.
<i>Slipped</i>	The product has hit an obstacle and stopped or the wheels cannot move on the wet grass.	Move the product and correct the cause of problem. If it is because of wet grass, wait until the lawn is dry before you use the product.
	The work area includes a steep slope.	Maximum guaranteed slope is 45%. Steeper slopes should be isolated. Refer to <i>To install the map objects in a slope on page 15</i> .
<i>Wheel motor overloaded right, left</i>	Grass or other objects is wound around the drive wheel.	Examine the drive wheel and remove grass or other objects.
<i>Charging station blocked</i>	The connection between the charging plates on the product and the contact plates on the charging station is not good. The product made a number of tries to charge.	Put the product in the charging station and make sure that the charging plates and contact plates are connected.
	An object prevents the product to enter the charging station.	Remove the object.
	The charging station tilts or is bent.	Put the baseplate on level ground.
<i>Stuck in charging station</i>	An object prevents the product to move out from the charging station.	Remove the object.
	The baseplate has a wet or dirty surface that prevents the product to move out from the charging station.	Clean the baseplate of the charging station.
<i>Upside down</i>	The product tilts or is with the top down.	Put the product in the correct position.
<i>Mower tilted</i>	The product tilts more than the maximum angle.	Move the product to an area that has level ground.
<i>Lifted</i>	The lift sensor was enabled because the product was lifted.	Move the product. If the problem stays, speak to your approved servicing dealer.
<i>Collision</i>	The body of the product cannot move freely around its chassis.	Remove dirt or object between the chassis and the body of the product. Make sure that the body of the product can move freely around its chassis.
	The product cannot move forward or rearward.	Remove the object that prevents the product from operation.

<b>Message</b>	<b>Cause</b>	<b>Action</b>
<i>Wheel motor blocked right/left</i>	The wheel is blocked by grass or other objects.	Examine the wheel and remove grass or other objects.
<i>Alarm! Mower stopped</i>	The alarm was started because the product was stopped.	Adjust the security settings in the <i>Security</i> menu. Refer to <i>Security (Bluetooth® only)</i> on page 23.
<i>Alarm! Mower outside Geo-fence</i>	Alarm was started because the product was moved out of the GeoFence area.	
<i>Alarm! Mower was moved</i>	The alarm was started because the product was moved.	
<i>Electronic problem</i>	Temporary electronic or firmware problem in the product.	Restart the product. If the problem stays, speak to your approved servicing dealer.
<i>Loop sensor problem</i>		
<i>Tilt sensor problem</i>		
<i>Temporary problem</i>		
<i>Invalid sub-device combination</i>		
<i>Temporary battery problem</i>		
<i>Faulty mix of batteries</i>		
<i>Collision sensor problem</i>		
<i>Lift sensor problem</i>		
<i>Charging system problem</i>	There is corrosion or dirt on the charging plates and contact plates.	Restart the product. Clean the charging plates on the product and the contact plates on the charging station.
	Temporary electronic or firmware problem in the product.	Restart the product. If the problem stays, speak to your approved servicing dealer.
<i>Battery problem</i>	Temporary battery or firmware problem in the product.	Restart the product. If the problem stays, speak to your approved servicing dealer.
	Incorrect type of battery.	Use only original batteries recommended by the manufacturer.
<i>Battery temperature outside limits</i>	The product cannot start because the temperature in the battery is too high or too low.	The product will start to operate when the temperature of the battery has decreased. Make sure that the charging station is put in an area with protection from the sun.
<i>Charging current too high</i>	Incorrect or defective power supply unit.	Examine that the power supply unit and charging station are not defective. Make sure that you use the correct power supply unit and charging station. Restart the product. If the problem stays, speak to your approved servicing dealer.

<b>Message</b>	<b>Cause</b>	<b>Action</b>
<i>Map problem</i>	There is no specified work area.	Make a work area in the Automower® Connect app. Refer to <i>To make a work area on page 19</i> .
	The map object file is incorrect.	Do a check of the map in the app. Adjust the map and save it.
		Delete the map and do a new installation.
<i>Work area tampered</i>	The charging station or the reference station was moved.	Move the charging station or the reference station to their initial positions.
		Do a new installation of the map.
<i>Wheel drive problem, right/left</i>	The wheel is blocked by grass or other objects.	Examine the drive wheel and remove grass or other objects.
<i>Searching for position</i>	Weak satellite signal to the reference station.	The satellite signal is temporary weak. The product will start to operate when the satellite signals are good.
		Examine the installation of the reference station. Refer to the Operator's manual for the Reference station.
	Weak satellite signal to the product.	The satellite signal is temporary weak. The product will start to operate when the satellite signal are good.
		Examine if there is an object between the product and the sky that cause interference with the satellite signal. Remove the object or do a new installation to not include these parts in the work area. Refer to <i>Installation of the map objects on page 17</i>
<i>No accurate position from satellites</i>	Weak satellite signal to the reference station.	Examine the installation of the reference station. Refer to the Operator's manual for the Reference station.
	Weak satellite signal to the product.	Examine if there is an object between the product and the sky that cause interference with the satellite signal. Remove the object or do a new installation to not include these parts in the work area. Refer to <i>To make a work area on page 19</i>

<b>Message</b>	<b>Cause</b>	<b>Action</b>
<i>Reference station communication problem</i>	The product is not connected to the reference station.	Do a pairing operation between the product and the reference station.
	The reference station is not installed correctly.	Examine the installation of the reference station. Refer to the Operator's manual for the Reference station.
	The product does not receive the radio signal from the reference station in all areas where the product operates.	Test if the product has radio signal from the reference station in all of the work area. If not, make a new installation of the reference station or a new installation of the map. Refer to <i>Installation of the map objects on page 17</i> .
	Power failure.	Examine and correct the cause for the power failure of the reference station.
	There is an error in the reference station and the LED indicator flashes red.	Disconnect the power to the reference station and connect it again to restart the reference station. If the problem stays, speak to your approved servicing dealer.
	There is interference with another reference station or other radio systems in the area.	Restart the product. If the problem stays, speak to your approved servicing dealer.
<i>Unexpected cutting height adj</i>	The cutting height adjustment cannot move.	Examine the cutting height adjustment and remove grass or other objects. If the problem stays, speak to your approved servicing dealer.
<i>Limited cutting height range</i>		
<i>Cutting height problem</i>		
<i>Cutting height blocked</i>		
<i>Cutting system major imbalance</i>	The product senses vibrations in the blade disc.	Make sure that the blades and screws are not damaged or worn. Make sure that all blades are correctly attached. Make sure that there is only one blade attached on each position in the blade disc.
<i>Too many waypoints</i>	There are too many waypoints in the current work area.	Do a new installation of the work area, stay-out zone and transport paths. Make less waypoints. Divide the current work area into more work areas.
<i>Destination not reachable</i>	There is no transport path between the charging station and the work area or maintenance point.	Make a transport path between the charging station and the work area or maintenance point.
	The transport path is blocked and the product cannot go to the work area, charging station or maintenance point.	Make sure that the transport path is not blocked, or delete the transport path and make a new transport path.

Message	Cause	Action
<i>No power in charging station</i>	Incorrect or damaged power supply.	Examine the power supply. If it is necessary, replace the power supply.
	Power failure.	Examine and correct the cause for the power failure of the reference station.
	The connection between the charging plates on the product and the contact plates on the charging station is not good.	Make sure that the charging plates and contact plates are connected.
<i>Multiple reference stations</i>	There is more than one reference station near the work area. This can cause interference for the product from a different reference station.	Speak to your approved servicing dealer if the same problem occurs frequently.

### 7.3 Information and warning messages

The information messages in the table below are shown in the *Messages* menu in the Automower® Connect app. Speak to your Husqvarna representative if the same message shows frequently.

Message	Cause	Action
<i>Cutting system imbalance</i>	The product senses vibrations in the blade disc.	Examine the blades and screws for damages and wear. Make sure that all blades are correctly installed and that there is only one blade attached in each position on the blade disc.
<i>Connectivity problem</i>	Problem with the Automower® Connect module.	Restart the product. If the connection problem stays, disconnect the product from Automower® Connect and do a new pairing operation. If the problem stays, speak to your local Husqvarna representative.
<i>Wrong PIN code</i>	An incorrect PIN code has been entered. 5 tries are permitted, and the product is then blocked for a period of time.	Enter the correct PIN code. If the PIN code is incorrect, use the link in the app to send the PIN code to your registered e-mail address. If you have not registered the e-mail address, speak to your local Husqvarna representative.
<i>Ultrasonic problem</i>	Temporary electronic or firmware related problem in the product.	Restart the product. If the problem stays, speak to your approved servicing dealer.
<i>GPS navigation problem</i>		

## 7.4 LED indicator lamp on the charging station

For a fully functional installation, the indicator lamp in the charging station must show a solid or flashing green light. If another color shows, follow the troubleshooting guide below.

There is more help on [www.husqvarna.com](http://www.husqvarna.com). If you still need help, speak to your local Husqvarna representative.

Light	Status
Green solid light	Good signals.
Green flashing light	The signals are good and <i>ECO mode</i> is activated. Refer to <i>ECO mode on page 22</i> .
Red flashing light	Interruption in the charging station's antenna. Speak to your local Husqvarna representative.
Red solid light	Fault in the circuit board or incorrect power supply in the charging station. The fault must be correct by an authorized service technician. Speak to your local Husqvarna representative.

## 7.5 LED indicator on the product

The LED indicator on the control panel of the product shows the current product status:

LED indicator light	Product status
Constant green	The product cuts the lawn or moves out of the charging station.
Flashes green	The product is in <i>Pause</i> mode.
Flashes red	The product stopped because of an error.
Constant yellow	The <b>STOP</b> button was pushed.
Flashes yellow	The PIN code must be entered to start the product.
Constant blue	The product moves to the charging station or a maintenance point.
	An app is connected to the product with Bluetooth®, the LED indicator is constant blue for 3 seconds.
Pulsates blue	The product charges in the charging station.
Flashes blue	The product is parked in charging station.
	The product can at this time find Bluetooth® and connect with Bluetooth®.
Constant white	The product is in appDrive mode.
Pulsates white	The product sets to OFF.
	Firmware installation is in progress.
Flashes white	New firmware must be installed.

There is more information on [www.husqvarna.com](http://www.husqvarna.com). Speak to your approved servicing dealer for more information.

## 7.6 Symptoms

If the product does not operate correctly, refer to the symptoms table below.

Symptoms	Cause	Action
The <b>Main switch</b> is set to the 0 position but the product is not set to OFF.	The <b>Main switch</b> is set to the 0 position but the product is not connected to the Automower® Connect app with Bluetooth®. The product is disabled but not set to OFF.	Set the <b>Main switch</b> to the 1 position, connect the product to the Automower® Connect app with Bluetooth® and set the <b>Main switch</b> to the 0 position.
The product cannot go into the charging station.	The charging station is not on a level surface.	Put the charging station on a level surface. Refer to <i>To examine where to put the charging station on page 11.</i>
	The charging station is put too far from the work area.	Make a new work area or move the charging station.
The product operates at the incorrect time.	The time and date of the product must be set.	Set the time and date. Refer to <i>Time &amp; date on page 23.</i>
	The start and stop time for operation are incorrect.	Change the schedule settings. Refer to <i>Schedule on page 21.</i>
There is vibration in the product.	The cutting system is not in balance because of damaged blades.	Examine the blades and screws and replace them if necessary. Refer to <i>Replacement of the blades on page 29.</i>
	The cutting system is not in balance because of too many blades in the same position.	Do a check that only one blade is attached to each screw.
	Blades of different thickness are installed on the product.	Examine if the blades are of different thickness and replace the blades if necessary.
The product operates, but the blade disc does not rotate.	The product goes to the charging station.	Usual operation of the product. The blade disc does not rotate when the product goes to the charging station.
The product operates for shorter periods than usual between charges.	Grass or other object causes a blockage to the blade disc.	Remove and clean the blade disc. Refer to <i>To clean the chassis and blade disc on page 28.</i>
	The battery is at the end of its life cycle.	Replace the battery. Refer to <i>Battery on page 29.</i>
	The grass is high and thick.	Increase the cutting height and then decrease it when the grass is shorter.
Operation and charging times are shorter than usual.	The battery is at the end of its life cycle.	Replace the battery. Refer to <i>Battery on page 29.</i>

Symptoms	Cause	Action
The product is parked for hours in the charging station.	The product is parked because of the set <i>Schedule</i> setting, or because <i>Park until further notice</i> is selected.	Change the <i>Schedule</i> settings, or start the product.
	The product does not operate if the battery temperature is too high or too low.	The product starts to operate again when the temperature is between the set limits and the schedule settings lets the product operate. Make sure that the charging station is put in an area with protection from the sun.
The product moves in circles or spirals.	The product operates frequently in <i>Spiral cutting</i> .	Adjust the intensity of the <i>Spiral cutting</i> or disable it if it is necessary. Refer to <i>Spiral cutting on page 22</i> .
The product operates on a small area for a number of minutes.	The product follows the GPS assisted navigation.	Usual operation of the product.
The product cannot connect to the mobile device.	The product is connected to a different mobile device or app.	Disable the app in all other connected devices.
The cut result is not satisfactory.	The product operates for a short period.	Increase the cutting time. Refer to <i>Schedule on page 21</i> .
		Increase the intensity level in the <i>Weather timer</i> or disable the <i>Weather timer</i> .
	The work area is too large.	Set a limit to the work area, or extend the operation time. Refer to <i>Schedule on page 21</i> .
	Blunt blades.	Replace all the blades. Refer to <i>Replacement of the blades on page 29</i> .
	Long grass in relation to the set cutting height.	Increase the cutting height and then lower it when the grass is shorter.
	Collection of grass by the blade disc or around the motor shaft.	Remove the collection of grass and clean the product. Refer to <i>To clean the chassis and blade disc on page 28</i> .
	The pattern or the direction of the pattern is unsatisfactory for the work area.	Select a different direction of the pattern or a different pattern.
Worn out grass in slopes.	The slope is too steep. The maximum guaranteed slope is 45%.	Isolate the slope with a stay-out zone.
	The pattern or the direction of the pattern is unsatisfactory for the slope.	Select a different direction of the pattern or a different pattern. For systematic pattern, Husqvarna recommends that the direction of the systematic pattern is straight up the slope and not parallel to it.



## 8 Transportation, storage and disposal

### 8.1 Transportation

The supplied Li-ion batteries obey the Dangerous Goods Legislation requirements.

- Obey all applicable national regulations.
- Obey the special requirement on package and labels for commercial transportations, including by third parties and forwarding agents.

### 8.2 Storage

- Fully charge the product. Refer to *To charge the battery on page 26*.
- Disconnect the product with the **Main switch**. Refer to *To set the product to OFF on page 26*.
- Clean the product. Refer to *Clean the product on page 28*.
- Keep the product in a dry, frost free space.
- Keep the product with all wheels on level ground during storage, or use a Husqvarna wall hanger.
- If you keep the charging station indoors, disconnect and remove the power supply from the charging station.

**Note:** If you keep the charging station outdoors, do not disconnect the power supply and the connectors.

### 8.3 Disposal

- Obey the local recycling requirements and applicable regulations.
- For questions about how to remove the battery, refer to *To remove the batteries on page 41*.

#### 8.3.1 To remove the batteries



**CAUTION:** Only remove the batteries when you dispose the product. When you remove the warranty seal, the Husqvarna warranty is no longer applicable.

1. Disconnect the product with the **Main switch**. Refer to *To set the product to OFF on page 26*.
2. Pull out the grommet on the charging cable at the very front of the product, and carefully remove the connector.
3. Lift the cover, one corner at a time.
4. Remove the 14 screws with a Torx 20.

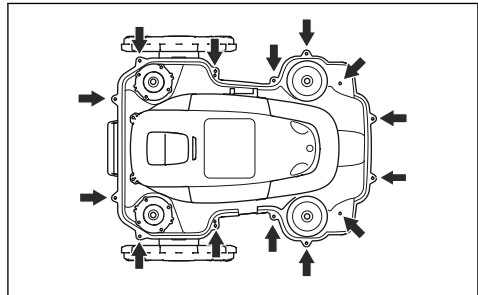

5. Lift the rear edge of the top section of the chassis.
6. Disconnect the cable from the main circuit board.
7. Remove the top section of the chassis.
8. Remove the 3 screws that holds the batteries with a Torx 20.

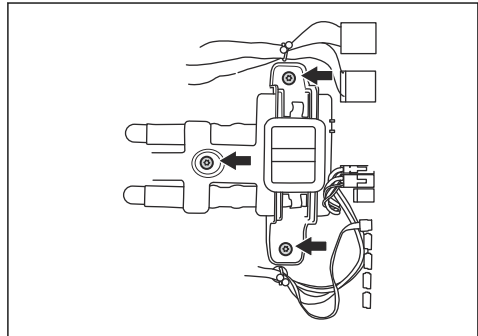

9. Disconnect the batteries connection from the main circuit board.

## 9 Technical data

### 9.1 Technical data

Dimensions	Automower® 550 EPOS
Length, cm / in.	72 / 28.3
Width, cm / in.	56 / 22.0
Height, cm / in.	32 / 12.6
Weight, kg / lbs	13.8 / 30.4

Electrical system	Automower® 550 EPOS
Battery, Lithium-Ion 18V, 5.0 Ah, Art. No	593 11 84-01, 593 11 85-01, 593 11 84-03, 593 11 84-04, 593 11 84-05, 593 11 84-06 (2 pcs.) 5.0 Ah/ battery
Battery, Lithium-Ion 18V, 4.9 Ah, Art. No	593 11 84-02, 593 11 85-02 (2 pcs.) 4.9 Ah/battery
Power supply (28V DC), V AC	100-240
Low-voltage cable for charging station, length m/ft.	10 / 33
Mean energy consumption at maximum use	23 kWh/month in a 5000 m <sup>2</sup> work area
Charging current, A DC	7
Type of Power Supply Unit for charging station <sup>5</sup>	FW7458/28/D/XX/Y, ADP-200MR XX
Average mowing time, min	210
Average charging time, min	60

Charging station wire antenna	Automower® 550 EPOS
Operating Frequency Band, Hz	100-80000
Maximum magnetic field, dBuA/m	82
Maximum Radio-frequency power <sup>6</sup> , mW @60m	<25 mW @60m

Noise emissions measured in the environment as sound power <sup>7</sup>	Automower® 550 EPOS
Sound level, perceived, dB (A)	68
Measured sound power noise level, dB (A)	68
Noise emissions uncertainties K <sub>WA</sub> , dB (A)	2
Sound pressure noise level at the operator's ear, dB (A) <sup>8</sup>	60

<sup>5</sup> XX, YY can be any alphanumeric characters or blank for marketing purpose only, no technical differences.

<sup>6</sup> Maximum active output power to antennas in the frequency band in which the radio equipment operates.

<sup>7</sup> Determined according to Directive 2006/42/EC and standard EN 50636-2-107. Except Sound level, perceived that is measured according to ISO 11094:1991.

<sup>8</sup> Sound pressure noise uncertainties K<sub>pA</sub>, 2-4 dB (A).

<b>Mowing</b>	<b>Automower® 550 EPOS</b>
Cutting system	5 pivoted cutting blades
Maximum cutting motor speed, rpm	2500
Power consumption during cutting, W +/- 20 %	35
Cutting height, cm / in.	2-6 / 0.8-2.4
Cutting width, cm / in.	24 / 9.4
Narrowest possible passage, m / ft.	2 / 6.5
Maximum angle for cutting area, %	45
Maximum angle for virtual boundary, %	15
Working area capacity, m <sup>2</sup> / acre(s), pro sports quality with irregular cutting	3500 / 0.9
Working area capacity, m <sup>2</sup> / acre(s), pro quality with irregular cutting	5000 / 1.25
Working area capacity, m <sup>2</sup> / acre(s), regular quality with irregular cutting	6000 / 1.5
Working area capacity, m <sup>2</sup> / acre(s), pro sports quality with systematic cutting	5000 / 1.25
Working area capacity, m <sup>2</sup> / acre(s), pro quality with systematic cutting	10000 / 2.5
Working area capacity, m <sup>2</sup> / acre(s), regular quality with systematic cutting	15000 / 3.7

<b>IP-code</b>	<b>Automower® 550 EPOS</b>
Robotic lawn mower	IPX4
Charging station	IPX1
Power supply charging station	IP44

<b>Frequency Band Support</b>	
Bluetooth® Frequency range	2400.0-2483.5 MHz
Automower® Connect 2G	GSM 850 MHz, E-GSM 900 MHz, DCS 1800 MHz, PCS 1900 MHz
Automower® Connect 4G	Band 12 (700 MHz), Band 17 (700 MHz), Band 28 (700 MHz), Band 13 (700 MHz), Band 20 (800 MHz), Band 26 (850 MHz), Band 5 (850 MHz), Band 19 (850 MHz), Band 8 (900 MHz), Band 4 (1700 MHz), Band 3 (1800 MHz), Band 2 (1900 MHz)
SRD868 (Europe)	863-870 MHz
SRD915 (North America)	902-928 MHz
SRD915 (Australia)	915-928 MHz
SRD915 (New Zealand)	915-928 MHz

<b>Power Class</b>		
Bluetooth® Output power	8 dBm	
Automower® Connect 2G	Power Class 4 (GSM/E-GSM)	33 dBm
	Power Class 1 (DCS/PCS)	30 dBm
	Power Class E2 (GSM/E-GSM)	27 dBm
	Power Class E2 (DCS/PCS)	26 dBm
Automower® Connect 4G	Power Class 3	23 dBm
SRD868 (Europe)	13 dBm	
SRD915 (North America)	13 dBm	
SRD915 (Australia)	13 dBm	
SRD915 (New Zealand)	13 dBm	

Full compatibility cannot be guaranteed between the product and other types of wireless systems such as remote controls, radio transmitters, hearing loops, buried electric animal fencing or similar.

The products are made in England or the Czech Republic. See information on the rating plate. Refer to *Product overview on page 8*.

## 9.2 Registered trademarks

The *Bluetooth®* word mark and logos are registered trademarks owned by *Bluetooth SIG, inc.* and any use of such marks by Husqvarna is under license.

# 10 Declaration of Conformity

## 10.1 Original EU Declaration of Conformity

### EU Declaration of Conformity

ROB-550EPOS-22-2E

We, Husqvarna AB, SE 561 82 Huskvarna, SWEDEN, Tel. +46 36 146500 declare on our sole responsibility that the products:

Description	Robotic lawn mower
Brand	HUSQVARNA
Type / Model	HUSQVARNA AUTOMOWER® 550 EPOS
Identification	Serial numbers dating from 2023 week 6

complies fully with the following EU directives and regulations:

Directive/Regulation	Description
2006/42/EC	"relating to machinery"
2014/53/EU	"relating to radio equipment"
2011/65/EU	"restriction of use of certain hazardous substances"

and that the following standards and/or technical specifications are applied;

IEC 60335-1:2010+A1:2013+A2:2016 (EN 60335-1:2012+AC:2014+A11:2014+A13:2017)

IEC 60335-2-107:2017+A1:2020 (EN 50636-2-107:2015+A1:2018+A2:2020)

EN ISO 12100:2010

EN IEC 63000:2018

EN 61000-6-1:2007

EN 61000-6-3:2007+A1:2011+AC:2012

ETSI EN 301 489-1 V2.2.3

ETSI EN 301 489-3 V2.1.1

ETSI EN 301 489-17 V3.1.1

ETSI EN 301 489-19 V2.1.1

ETSI EN 301 489-52 V1.1.0

ETSI EN 303 447 V1.3.0

ETSI EN 300 328 V2.2.2

ETSI EN 300 220-1 V3.1.1

ETSI EN 300 220-2 V3.2.1

ETSI EN 301 908-1 V15.1.1

ETSI EN 301 908-13 V13.1.1

ETSI EN 301 511 V.12.5.1

ETSI EN 303 413 V1.2.1

The notified body CETECOM GmbH, No. 0680, has issued a type examination certificate with no. M22-1047-01-TEC covering Art. 3.2 of 2014/53/EU.

*Manne Alzén*

Manne Alzén (Dec 22, 2022 14:23 GMT+1)

Manne Alzén

Husqvarna

Director Pro Robotics R&D  
Husqvarna AB, Husqvarna Forest and Garden  
Responsible for technical documentation



## 10.2 Translated EU Declaration of Conformity

We, Husqvarna AB, SE 561 82 Huskvarna, SWEDEN,  
Tel. +46 36 146500 declare on our sole responsibility  
that the product:

<b>Description</b>	<b>Robotic lawn mower</b>
<b>Brand</b>	Husqvarna
<b>Type/Model</b>	HUSQVARNA AUTOMOWER® 550 EPOS
<b>Identification</b>	Serial numbers dating from 2023 week 6

complies fully with the following EU directives and regulations:

<b>Directive/Regulation</b>	<b>Description</b>
2006/42/EC	"Relating to machinery"
2014/53/EU	"Relating to radio equipment"
2011/65/EU	"Restriction of use of certain hazardous substances"

and that the following standards and/or technical specifications are applied;

- EC 60335-1:2010+A1:2013+A2:2016 (EN 60335-1:2012+AC:2014+A11:2014+A13:2017)
- IEC 60335-2-107:2017+A1:2020 (EN 50636-2-107:2015+A1:2018+A2:2020)
- EN ISO 12100:2010
- EN IEC 63000:2018
- EN 61000-6-1:2007
- EN 61000-6-3:2007+A1:2011+AC:2012
- ETSI EN 301 489-1 V2.2.3
- ETSI EN 301 489-3 V2.1.1
- ETSI EN 301 489-17 V3.1.1
- ETSI EN 301 489-19 V2.1.1
- ETSI EN 301 489-52 V1.1.0
- ETSI EN 303 447 V1.3.0
- ETSI EN 300 328 V2.2.2
- ETSI EN 300 220-1 V3.1.1

- ETSI EN 300 220-2 V3.2.1
- ETSI EN 301 908-1 V15.1.1
- ETSI EN 301 908-13 V13.1.1
- ETSI EN 301 511 V.12.5.1
- ETSI EN 303 413 V1.2.1

The notified body CETECOM GmbH, No. 0680,  
has issued a type examination certificate with no.  
M22-1047-01-TEC covering Art. 3.2 of 2014/53/EU.

Manne Alzén

Huskvarna

Director Pro Robotics R&D. Husqvarna AB, Huskvarna  
Forest and Garden. Responsible for technical  
documentation.



### 10.3 Original UK Declaration of Conformity

#### Declaration of Conformity

ROB-550EPOS-22-1U

We, Husqvarna AB, SE 561 82 Huskvarna, SWEDEN, Tel. +46 36 146500 declare on our sole responsibility that the product:

Description	Robotic lawn mower
Brand	HUSQVARNA
Type / Model	HUSQVARNA AUTOMOWER® 550 EPOS
Identification	Serial numbers dating from 2023 week 6

complies fully with the following UK regulations:

Regulation	Description
S.I. 2008/1597	The Supply of Machinery (Safety) Regulations 2008
S.I. 2017/1206	The Radio Equipment Regulations 2017
S.I. 2012/3032	The Restriction of the Use of Certain Hazardous Substances in Electrical and Electronic Equipment Regulations 2012

and that the following standards and/or technical specifications are applied;

IEC 60336-1:2010+A1:2013+A2:2016 (EN 60335-1:2012+AC:2014+A11:2014+A13:2017)  
IEC 60335-2-107:2017+A1:2020 (EN 50636-2-107:2015+A1:2018+A2:2020)  
EN ISO 12100:2010  
EN IEC 63000:2018  
EN 61000-6-1:2007  
EN 61000-6-3:2007+A1:2011+AC:2012  
ETSI EN 301 489-1 V2.2.3  
ETSI EN 301 489-3 V2.1.1  
ETSI EN 301 489-17 V3.1.1  
ETSI EN 301 489-19 V2.1.1  
ETSI EN 301 489-52 V1.1.0  
ETSI EN 303 447 V1.3.0  
ETSI EN 300 328 V2.2.2  
ETSI EN 300 220-1 V3.1.1  
ETSI EN 300 220-2 V3.2.1  
ETSI EN 301 908-1 V15.1.1  
ETSI EN 301 908-13 V13.1.1  
ETSI EN 301 511 V.12.5.1  
ETSI EN 303 413 V1.2.1

The notified body CETECOM GmbH, No. 0680, has issued a type examination certificate with no. M22-1047-01-TEC covering Art. 3.2 of 2014/53/EU.

*Manne Alzén*

Manne Alzén (Dec 22, 2022 14:23 GMT+1)

Manne Alzén  
Huskvarna

Director Pro Robotics R&D  
Husqvarna AB, Husqvarna Forest and Garden  
Responsible for technical documentation

**UK  
CA**

UK Importer:  
Husqvarna UK Limited  
Preston Road, Aycliffe  
Business Park Newton  
Aycliffe, County Durham  
UK DL5 6UP



**Husqvarna**<sup>®</sup>

AUTOMOWER<sup>®</sup> is a trademark owned by Husqvarna AB.  
Copyright<sup>®</sup> 2023 HUSQVARNA. All rights reserved.

[www.husqvarna.com](http://www.husqvarna.com)

---

Original instructions



1143075-26



2023-02-02